

**(PL)** Instrukcja montażu

**(GB)** Assembly instructions

**(D)** Montageanleitung

**(FR)** Notice de montage

**(IT)** Istruzioni di montaggio

**(RU)** Инструкция по монтажу

Nazwa /Name /Name /Nom /Nome /Имя

# RIVA 560

UWAGA / REMARQUE / NOTE / ATENZIONE / HINWEIS / ВНИМАНИЕ

**(PL)** Objętość wody w basenie 14,44 m<sup>3</sup>

**(FR)** Le volume de l'eau dans la piscine 14,44 m<sup>3</sup>

**(GB)** Water capacity in the pool 14,44 m<sup>3</sup>

**(IT)** Il volume di acqua in piscina 14,44 m<sup>3</sup>

**(D)** Volumen von Wasser im Schwimmbecken 14,44 m<sup>3</sup>

**(RU)** Объем воды в бассейне 14,44 м<sup>3</sup>

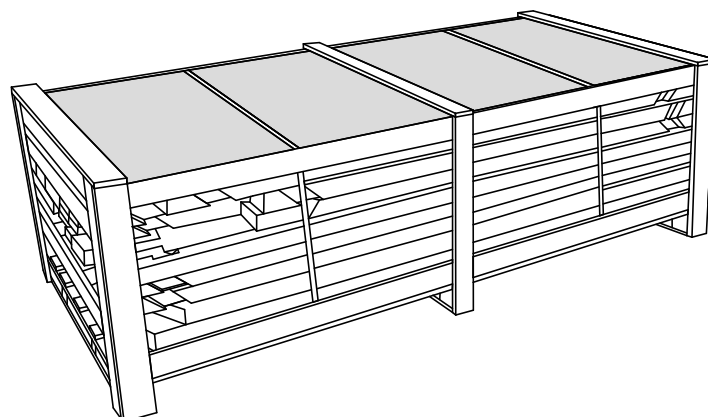
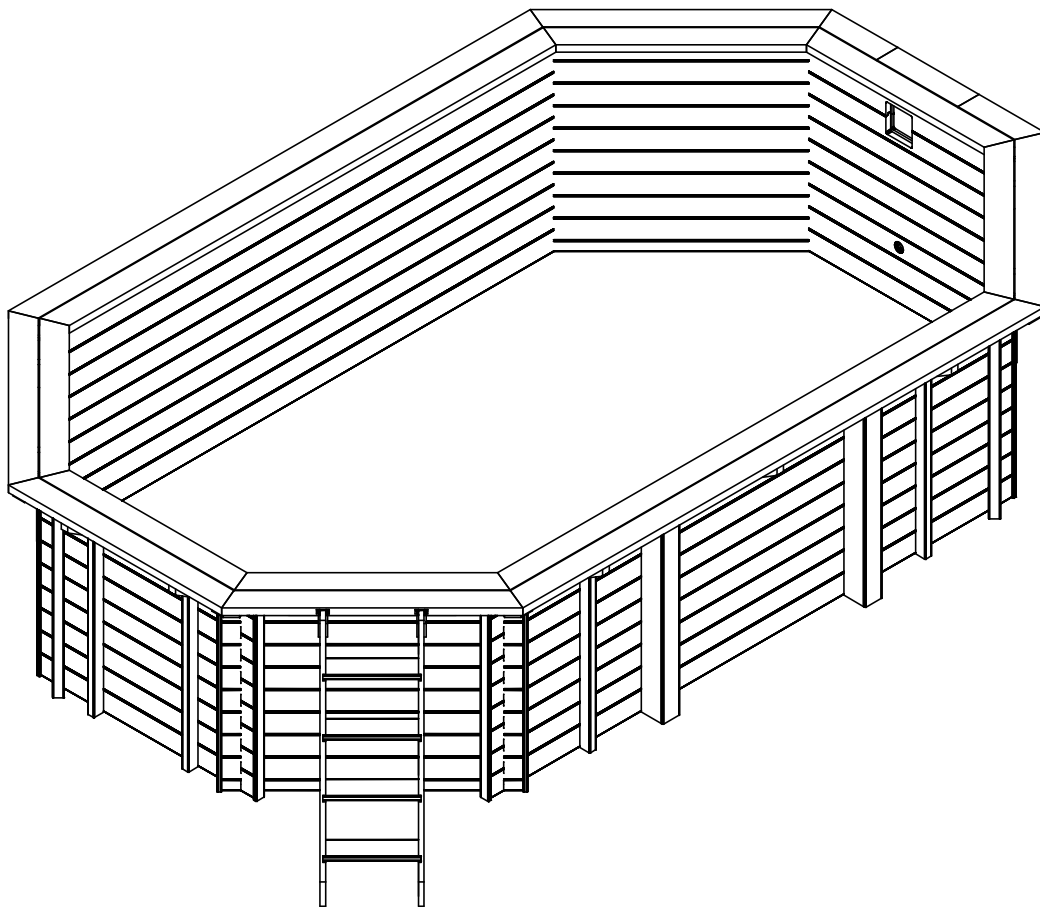

**(PL)** Instrukcja montażu

**(GB)** Assembly instructions

**(DE)** Montageanleitung

**(FR)** Notice de montage

**(IT)** Istruzioni di montaggio

**(NL)** Montage-instructies



**(PL)** Przed przystąpieniem do montażu zapoznaj się z instrukcją.

**(FR)** Avant le montage lisez attentivement la notice.

**(GB)** Read carefully pool installation manual before the installation.

**(IT)** Prima del montaggio é necessario consultare il manuale.

**(DE)** Lesen Sie das Pool-Installationshandbuch vor der Installation sorgfältig durch.

**(NL)** Lees zorgvuldig de handleiding van het zwembad voordat u met de installatie begint.

## **UWAGA / REMARQUE / NOTE / ATATTENZIONE / HINWEIS / OPMERKING**

*Instrukcja, którą posiadacie Państwo w ręku pokazuje krok po kroku w jaki sposób dokonać właściwego montażu basenu. Dołożyliśmy wszelkich starań, aby przygotować materiały jak najbardziej odzwierciedlające stan faktyczny i wygląd poszczególnych elementów. Jednak proszę pamiętać, że wszelkie rysunki mają charakter poglądowy i istnieje możliwość, że poszczególne elementy dostarczone w Państwa zestawie w rzeczywistości mogą odbiegać wyglądem od ich wizualizacji graficznej zawartej w instrukcji.*

**(PL)**

*Le manuel que vous avez entre les mains montre étape par étape comment assembler correctement la piscine. Nous avons fait tous les efforts pour préparer les documents reflétant autant que possible l'état réel et l'apparence des éléments particuliers. Pourtant, il faut savoir que tous les dessins sont présentés à titre de référence et qu'il est possible que les éléments singuliers fournis dans votre kit puissent différer en apparence de leur visualisation graphique incluse dans le manuel.*

**(FR)**

*This manual presents the correct assembly procedure for the swimming pool, step by step. We have undertaken all possible efforts to make sure that the materials are as close to the actual items and present their layout as closely as possible. Please remember, however, that all figures are indicative only and individual elements delivered in your set may be different than their graphical visualisations presented in the manual.*

**(GB)**

*Le presenti istruzioni spiegano passo dopo passo come montare correttamente la piscina. Abbiamo fatto del nostro meglio per preparare i materiali che rispecchiano il più fedelmente possibile lo stato reale e l'aspetto dei singoli elementi. Occorre però ricordare che le figure hanno carattere illustrativo ed è possibile che i singoli elementi forniti nel Vostro kit avranno l'aspetto diverso dalla loro visualizzazione grafica contenuta nelle istruzioni.*

**(IT)**

*Die Ihnen vorliegende Anleitung erläutert Ihnen Schritt für Schritt, wie das Schwimmbecken korrekt montiert wird. Wir haben alles daran gesetzt, die Unterlagen bestmöglich an den tatsächlichen Zustand und das Aussehen der einzelnen Teile anzupassen. Bitte bedenken Sie jedoch, dass alle Zeichnungen nur zu Anschauungszwecken dienen. Deshalb kann es sein, dass einzelne Teile in Ihrem Set anders aussehen, als in der graphischen Visualisierung in der Anleitung.*

**(DE)**

*Deze handleiding presenteert stap voor stap hoe u het zwembad op de juiste manier kunt monteren. We hebben er alles aan gedaan om een handleiding te maken die een realistisch beeld weergeeft van de montage en onderdelen.*

**(NL)**

*Houd echter wel rekening mee dat alle tekeningen alleen ter referentie dienen en dat het mogelijk is dat de afzonderlijke elementen in uw set kunnen afwijken van de grafische tekeningen in deze handleiding.*

**(PL)** Instrukcja montażu

**(GB)** Assembly instructions

**(DE)** Montageanleitung

**(FR)** Notice de montage

**(IT)** Istruzioni di montaggio

**(NL)** Montage-instructies



**(PL)** Przed przystąpieniem do montażu zapoznaj się z instrukcją. \* Bez wylewki betonowej.

**(FR)** Avant le montage lisez attentivement la notice. \* Sans dalle de béton.

**(GB)** Read carefully pool installation manual before the installation. \* Without concrete base.

**(IT)** Prima del montaggio è necessario consultare il manuale. \* Senza una lastra di cemento.

**(DE)** Lesen Sie das Pool-Installationshandbuch vor der Installation sorgfältig durch. \* Ohne Betonbasis.

**(NL)** Lees zorgvuldig de handleiding van het zwembad voordat u met de installatie begint. \* Zonder betonnen basis.

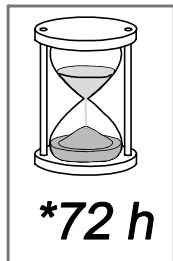

\*72 h

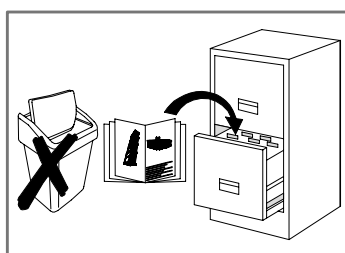
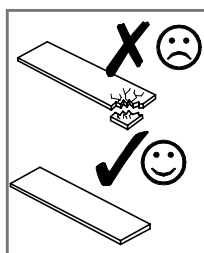
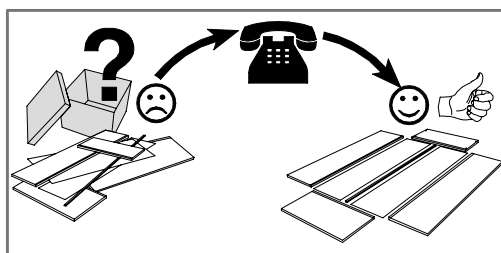
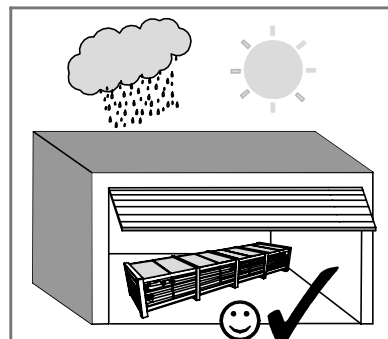
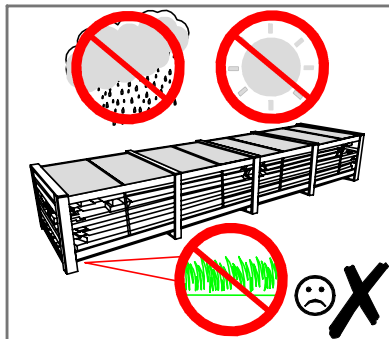
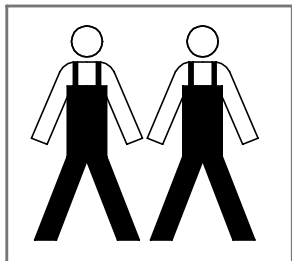

**UWAGA / REMARQUE / NOTE / ATENZIONE / HINWEIS / OPMERKING**

**(PL)** Montaż wykonać w przeciągu 3 dni od rozpakowania struktury.

**(FR)** Le montage de la structure doit être terminé dans un délai de 3 jours suivant l'ouverture de l'emballage.

**(GB)** Installation should be finished within 3 days from opening the package.

**(IT)** Il montaggio effettuare entro 3 giorni dal disimballo della struttura.

**(DE)** Die Installation sollte innerhalb von 3 Tagen nach dem Öffnen des Pakets abgeschlossen sein.

**(NL)** De installatie moet binnen 3 dagen na opening van het pakket worden voltooid.



**UWAGA / REMARQUE / NOTE / ATENZIONE / HINWEIS / OPMERKING**

**(PL)** Brak corocznej konserwacji struktury powoduje utratę gwarancji.

**(FR)** En cas de défaut d'entretien annuel de la structure, la garantie est invalidée.

**(GB)** Lack of once a year conservation of the structure causes loss of warranty.

**(IT)** Mancanza della manutenzione annuale causa la perdita di garanzia.

**(DE)** Der Mangel an einmal jährlichem Schutz der Struktur verursacht einen Garantieverlust.

**(NL)** Het uitblijven van onderhoud aan de constructie eenmaal per jaar zorgt voor verval van de garantie.



**UWAGA / REMARQUE / NOTE / ATENZIONE / HINWEIS / OPMERKING**

**(PL)** Nie pozostawiać dzieci bez nadzoru!

**(FR)** Ne laissez pas les enfants sans surveillance!

**(GB)** Do not leave children unattended!

**(IT)** Non lasciare bambini incustoditi!

**(DE)** Lassen Sie Kinder nicht unbeaufsichtigt!

**(NL)** Laat kinderen niet zonder toezicht!

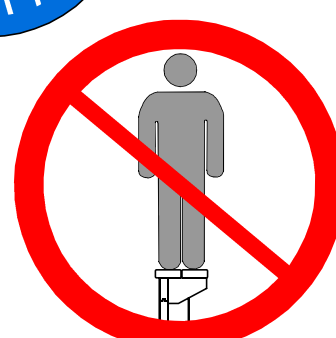
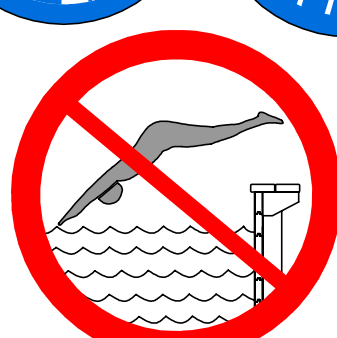

**PL** Elementy

**GB** Elements

**D** Elemente

**FR** Les éléments

**IT** Elementi

**RU** Элементы



**PL** Sprawdź ilość oraz czy elementy nie są uszkodzone.

**FR** Vérifiez la quantité et si les éléments ne sont pas abîmés.

**GB** Check quantity of elements and if they are not faulty.

**IT** Controllare la quantità e se gli elementi non sono danneggiati.

**D** Überprüfen Sie die Menge, und ob die Elemente nicht beschädigt sind.

**RU** Проверить количество, а также не повреждены ли детали.

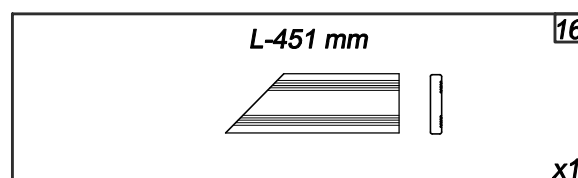
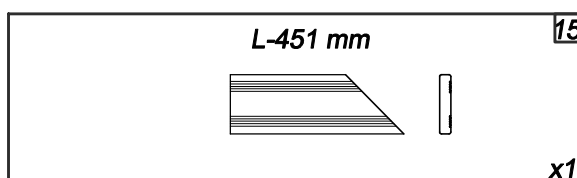
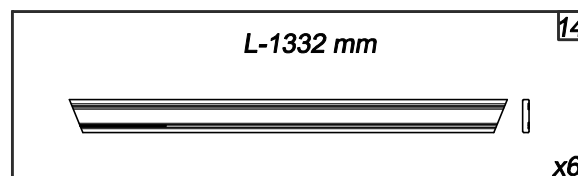
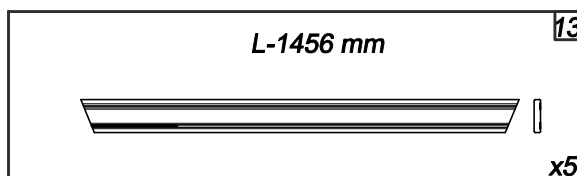
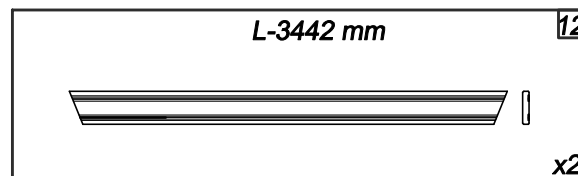
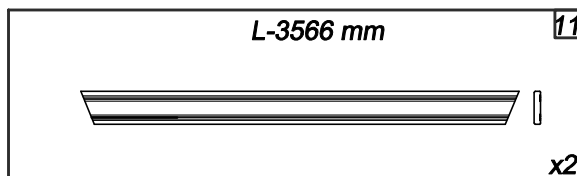
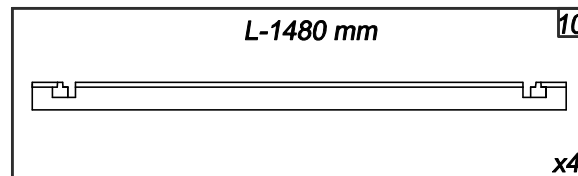
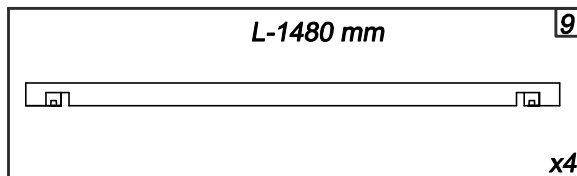
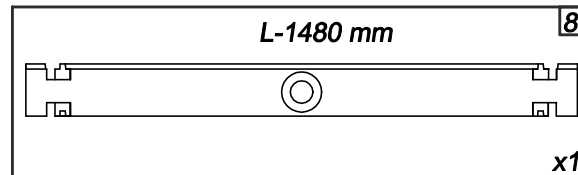
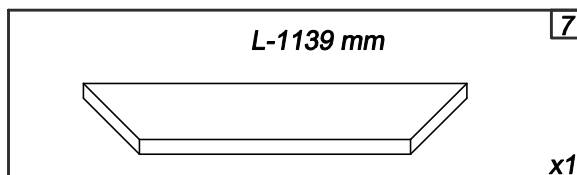
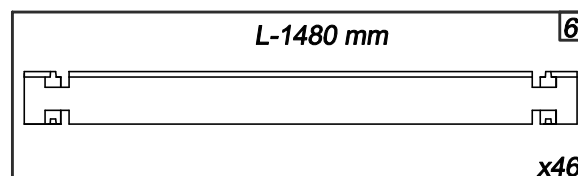
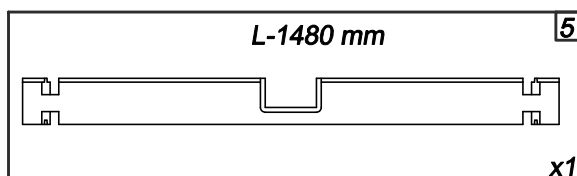
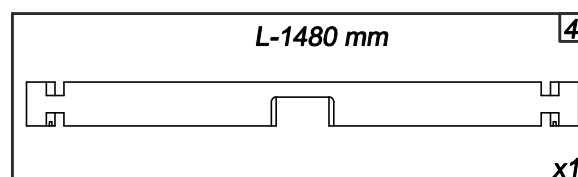
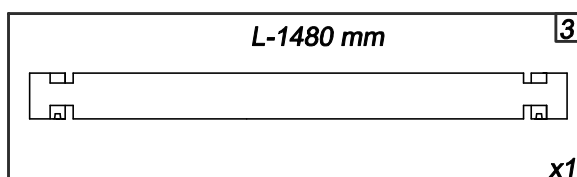
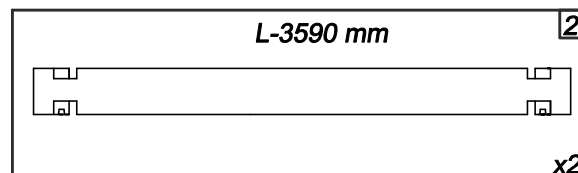
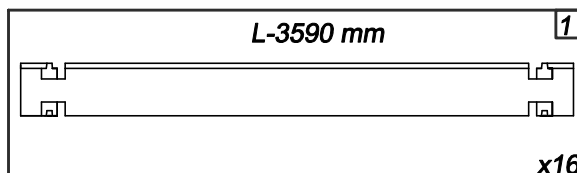
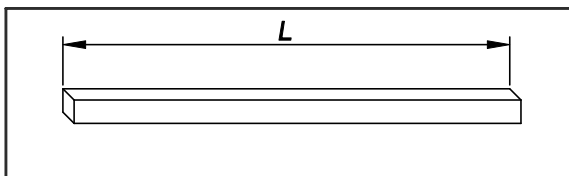



**PL** Elementy

**GB** Elements

**D** Elemente

**FR** Les éléments

**IT** Elementi

**RU** Элементы



**PL** Sprawdź ilość oraz czy elementy nie są uszkodzone.

**FR** Vérifiez la quantité et si les éléments ne sont pas abîmés.

**GB** Check quantity of elements and if they are not faulty.

**IT** Controllare la quantità e se gli elementi non sono danneggiati.

**D** Überprüfen Sie die Menge, und ob die Elemente nicht beschädigt sind.

**RU** Проверить количество, а также не повреждены ли детали.

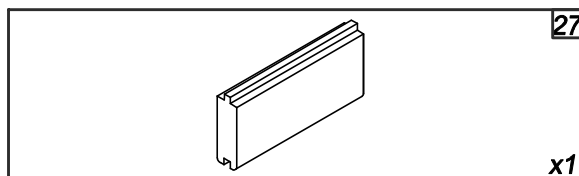
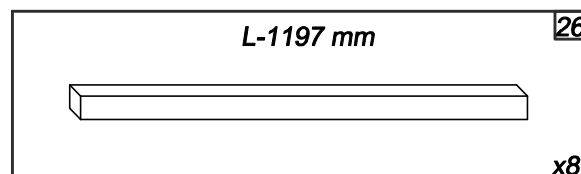
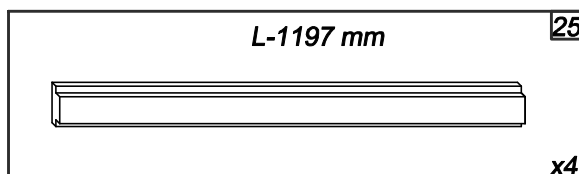
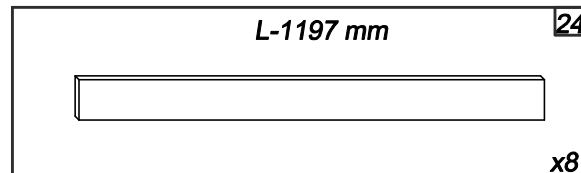
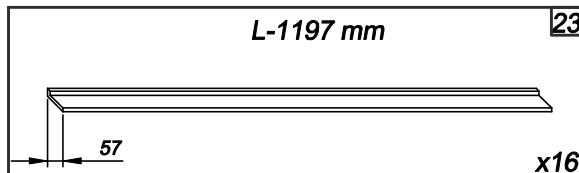
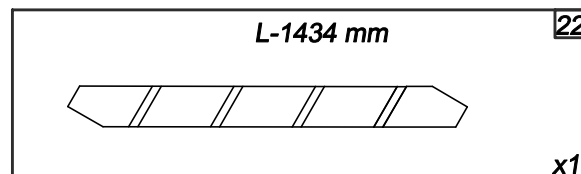
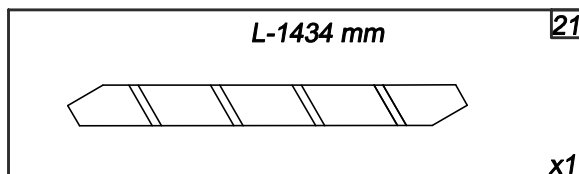
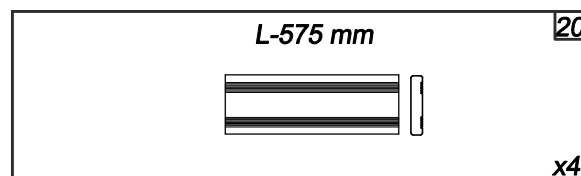
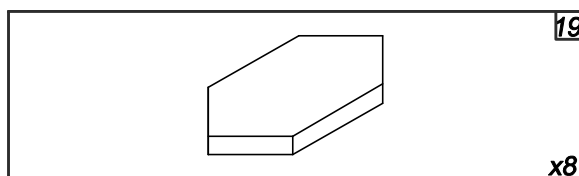
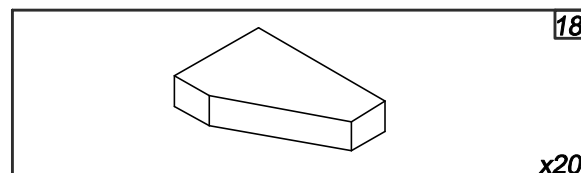
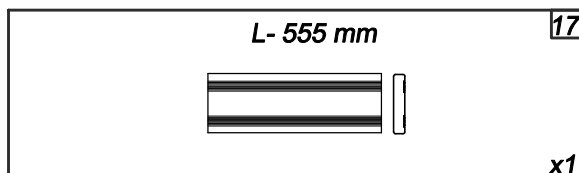
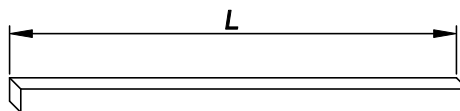

**PL** Okucia i osprzęt

**GB** Fittings and equipment

**D** Beschläge und Ausrüstung

**FR** Quincaillerie et l'équipement

**IT** Ferramenti e accessori

**RU** Фурнитура и оборудование



**PL** Sprawdź ilość.

**FR** Vérifiez la quantité.

**GB** Check quantity.

**IT** Controllare la quantità.

**D** Überprüfen Sie die Menge.

**RU** Проверить количество.

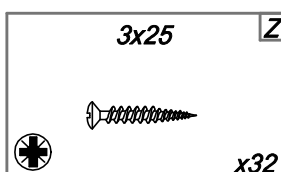
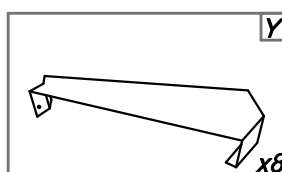
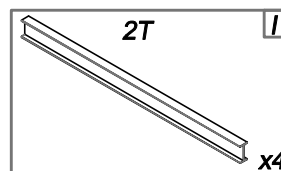
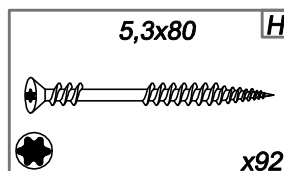
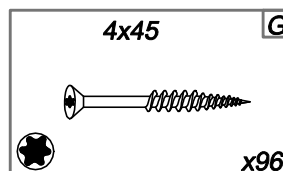
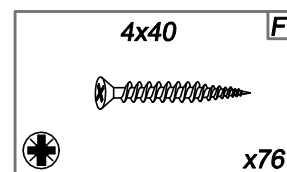
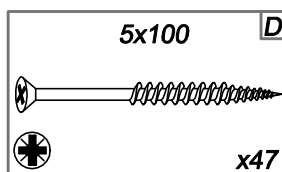
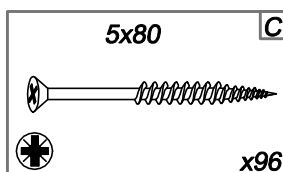
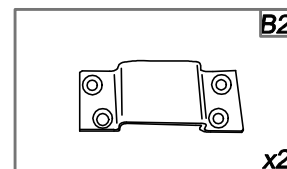
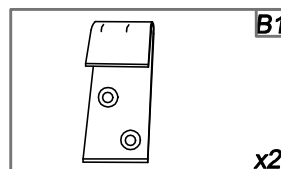

**PL** Narzędzia

**GB** Tools

**D** Werkzeuge

**FR** Les outils

**IT** Strumenti

**RU** Инструменты

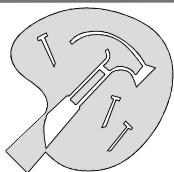

**PL** Przygotuj niezbędne narzędzia - niezawarte w zestawie.

**FR** Préparez les outils nécessaires - pas inclus.

**GB** Prepare essential tools- not included.

**IT** Preparare gli strumenti necessari - non inclusi nel set.

**D** Bereiten Sie notwendiges, nicht im Satz enthaltenes Werkzeug vor.

**RU** Приготовить необходимые инструменты - не содержатся в комплекте.

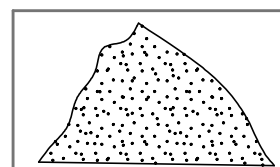
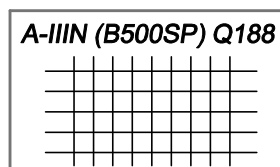
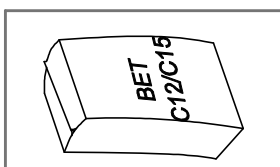
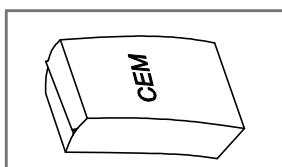
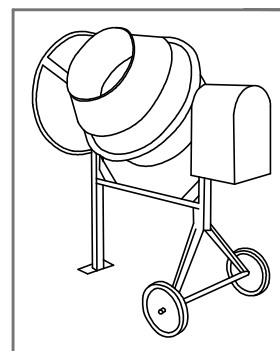
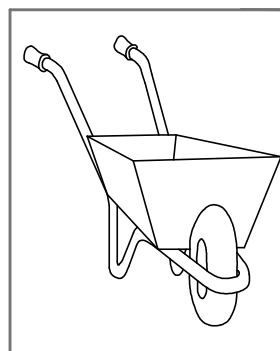
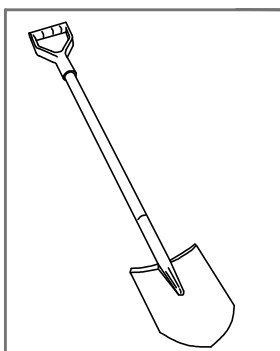
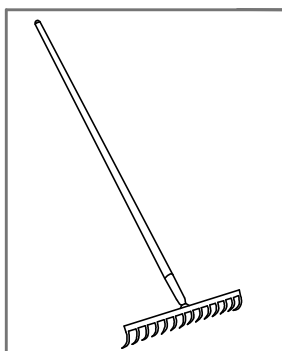
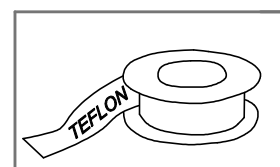
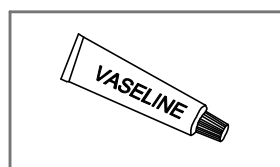
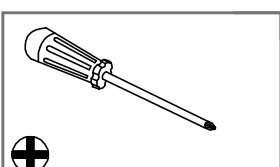
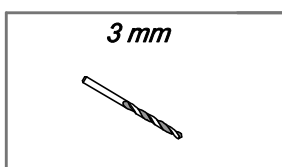
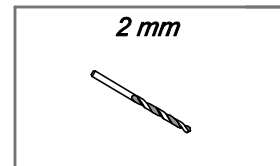
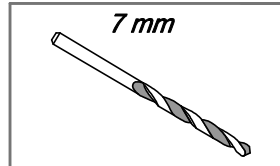
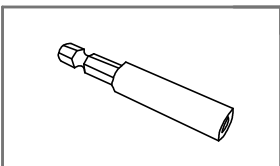
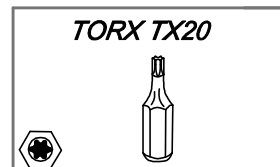
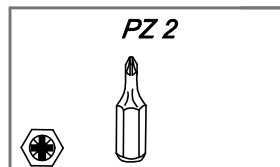
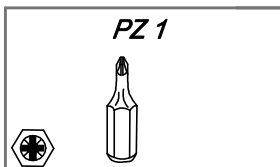
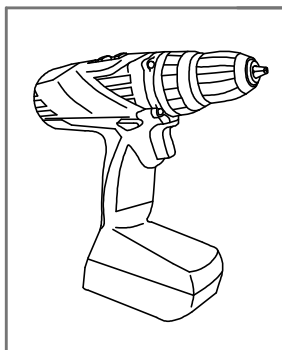
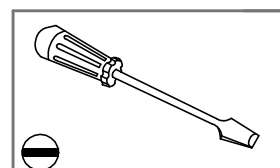
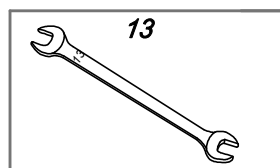
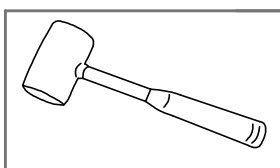
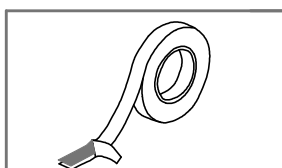
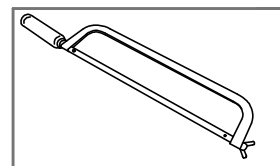
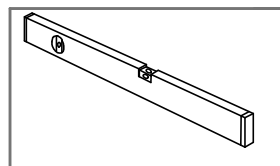
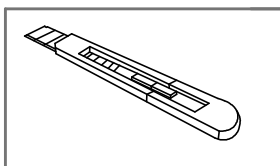
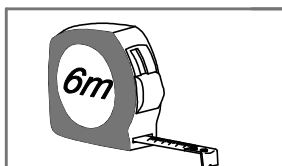
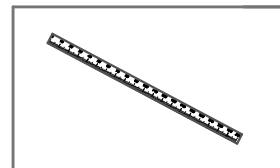
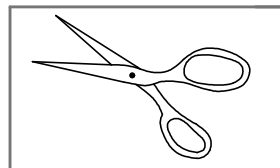
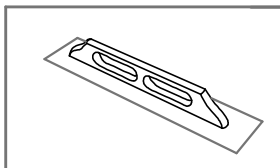
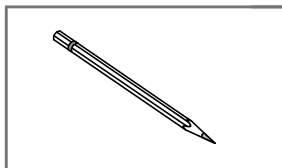

**(PL) Podłoże**

**(GB) Ground**

**(D) Untergrund**

**(FR) Terrain**

**(IT) Suolo**

**(RU) база**



**(PL)** Struktura basenu wkopanego musi być zabezpieczona zgodnie z dołączoną dodatkowo dokumentacją.

**(FR)** Il est exigé que la structure de la piscine enterrée soit convenablement protégée selon les indices dans le document supplémentaire ci-joint.

**(GB)** Structure of in-ground pool must be secured in accordance with additional enclosed documentation.

**(IT)** È esatto che la struttura della piscina seppellita sia protetta correttamente in allegato secondo gli indizi nel documento supplementare.

**(D)** Die Struktur des Pools, der ausgegraben wird, muss gesichert werden, gemäß information in der Begleitdokumentation.

**(RU)** Структура вкапываемого бассейна должна быть защищена строительной пленкой.

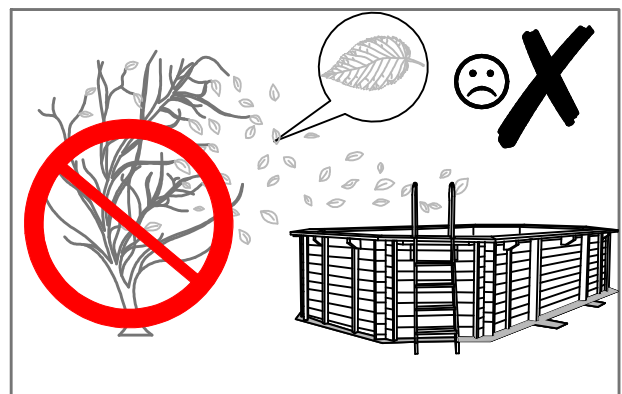
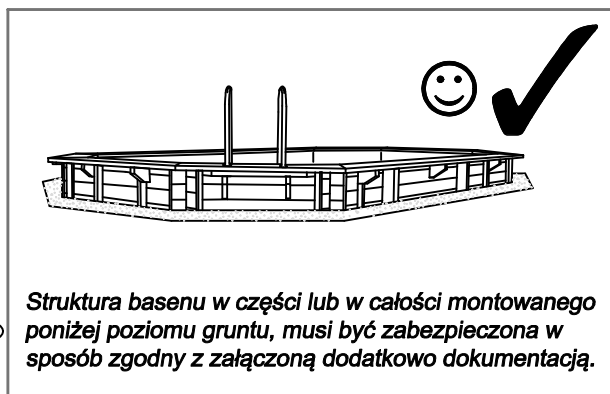
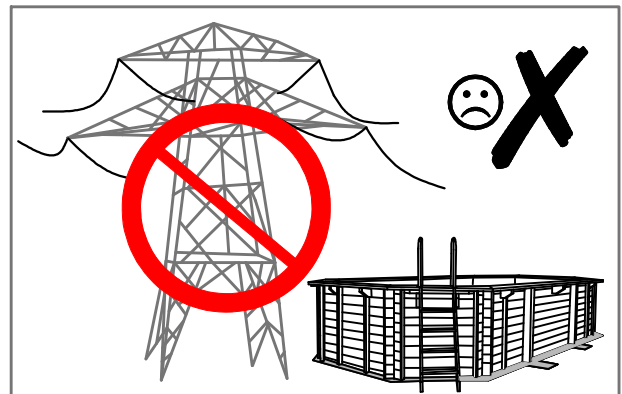
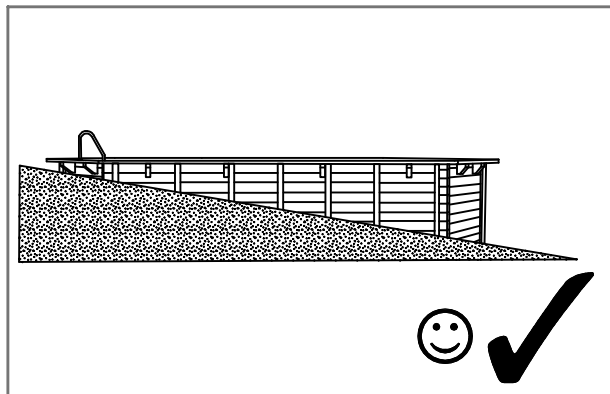
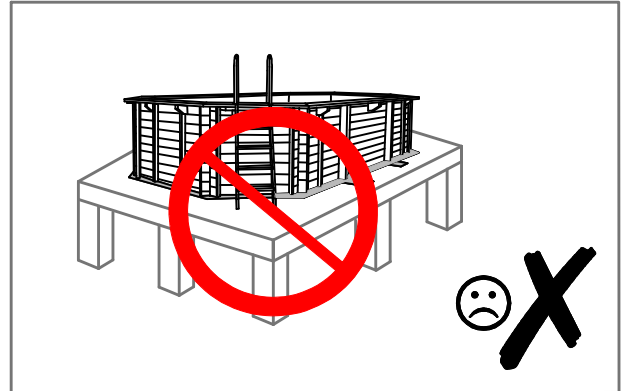
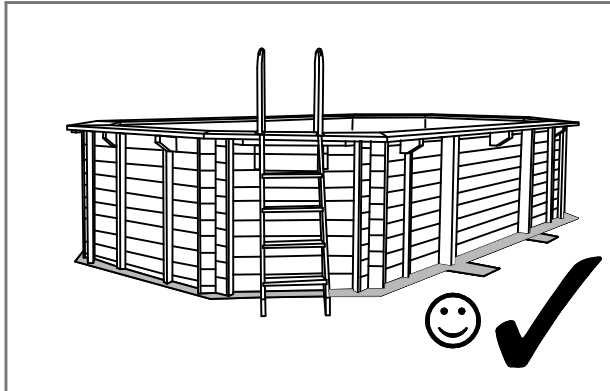

**(PL)**

Struktura basenu w części lub w całości montowanego poniżej poziomu gruntu, musi być zabezpieczona w sposób zgodny z załączoną dodatkowo dokumentacją.

**(FR)**

Il est exigé que la structure de la piscine enterrée ou semi-enterrée soit convenablement protégée selon les indices dans le document supplémentaire ci-joint.

**(GB)**

Structure of partly or fully in-ground pool, must be secured in accordance with additional enclosed documentation.

**(IT)**

È esatto che la struttura della piscina sepolta o semi-sepolta sia protetta correttamente in allegato secondo gli indizi nel documento supplementare.

**(D)**

Die Struktur des Pools, die teilweise oder vollständig unter der Erdoberfläche montiert ist, muss gemäß der beiliegenden Dokumentation gesichert werden.

**(NL)**

De constructie van het half- of volledig ingebouwde zwembad moet beschermd worden volgens de instructies in bijgaande documentatie.

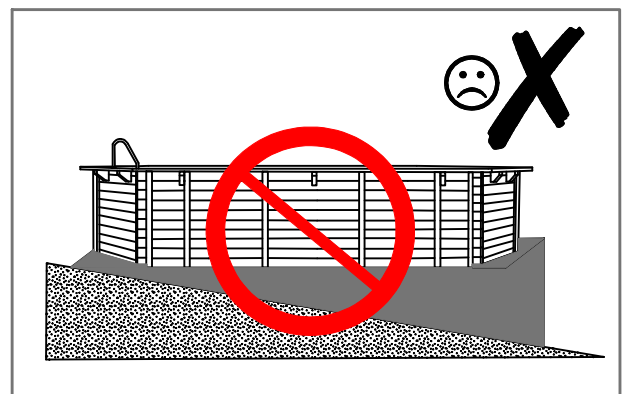

**(PL) Podłoże**

**(GB) Ground**

**(DE) Untergrund**

**(FR) Terrain**

**(IT) Suolo**

**(NL) Ondergrond**



- (PL)** Wymagane zabezpieczenie struktury przy montażu basenu poniżej poziomu gruntu.  
**(FR)** La protection de la structure dans le cas de la piscine totalement ou partiellement enterrée.  
**(GB)** Wooden structure protection required in case of in-ground installation.  
**(IT)** La protezione della struttura nel caso della piscina totalmente o parzialmente sepolta.  
**(DE)** Erforderliches Schutz für Struktur eines Holzpool, wenn es unter der Boden montieren.  
**(NL)** Bescherming van de houten constructie is absoluut noodzakelijk bij ingebouwde zwembaden.

- 1** FUNDAMENT BASENU / DALLE BETON / FOUNDATION / LASTRA CEMENTO / DAS FUNDAMENT / FUNDERING
- 2** RURA DRENARSKA / TUYAU DE DRAINAGE / DRAINAGE PIPE / TUBO DI DRENAGGIO / DIE DRAINAGEROH / AFVOERPIJP
- 3** PEČERZYKOWA FOLIA FUNDAMENTOWA / PROTECTION DE SOUBASSEMENT / FOINDATION BUBBLE WRAP / FONDALINE / DAS FUNDAMENT NOPPENFOLIE / BOUWFOLIE
- 4** ŻWIR / GRAVIER / GRAVEL / GHIAIA / DER KIES / GRAVEL
- 5** GEOWŁÓKNINA OGRODOWA / GEOTEXTILE / GEOTEXTILE / GEOTESSILI / GARTEN GEOTEXTILE / GEOTEXTEL
- 6** GRUNT / TERRAIN / GROUND / TERRENO / DER BODEN / BODEM

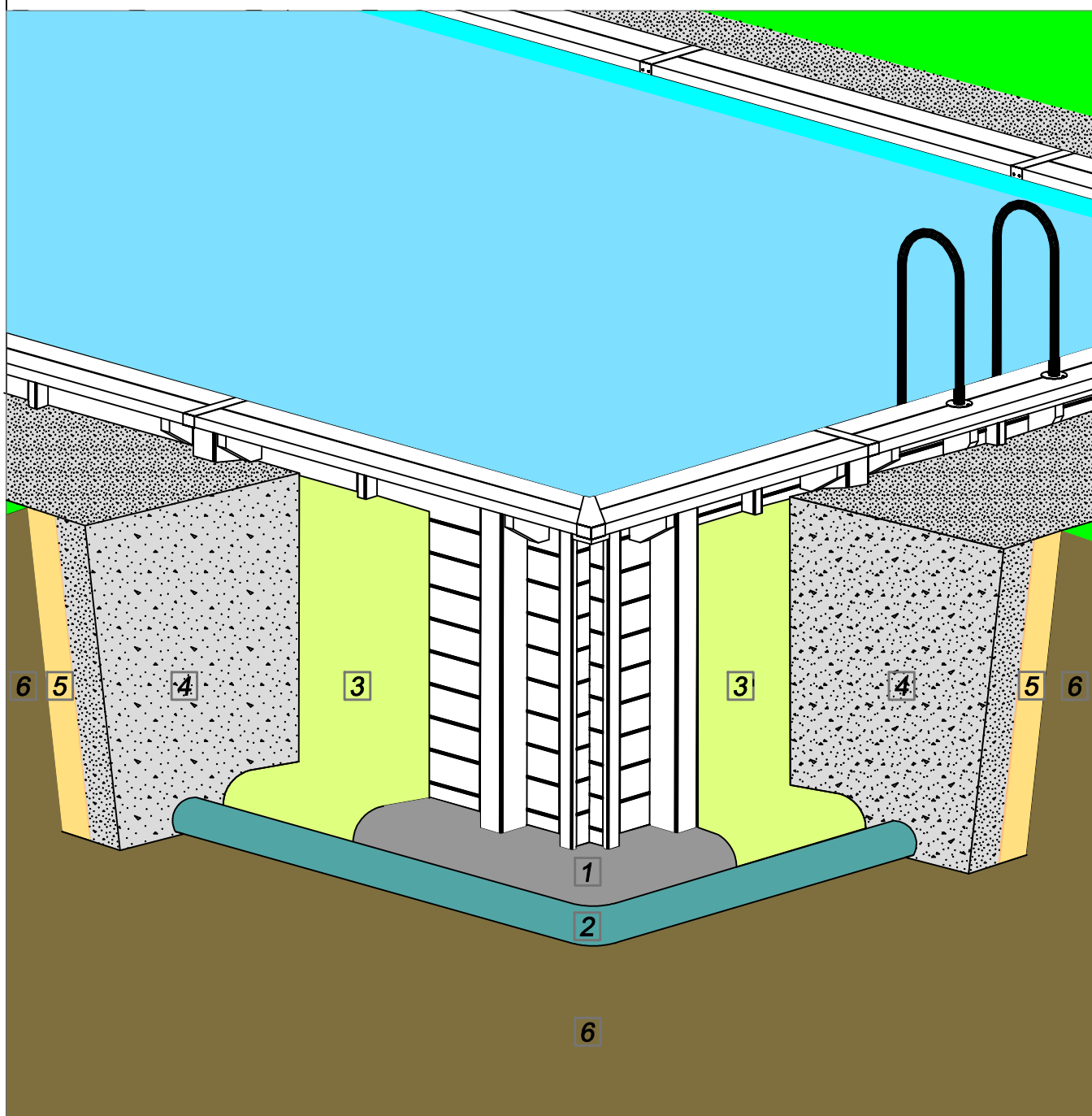



**PL** Podłoże

**GB** Ground

**D** Untergrund

**FR** Terrain

**IT** Suolo

**RU** база



**PL** Schemat przygotowania wykopu / podłoża pod zbrojoną wylewkę betonową.

**FR** Schema de préparation de l'excavation / du terrain pour la dalle en béton armé.

**GB** Diagram of preparation of trench / subfloor for reinforced concrete screed.

**IT** Schema per la preparazione degli scavi / substrato ricoperto da cemento armato.

**D** Schema der Vorbereitung der Ausschachtung / Untergrund für den bewehrten Betonestrich.

**RU** Схема размещения стоек и подготовки бетонного основания.

[mm]

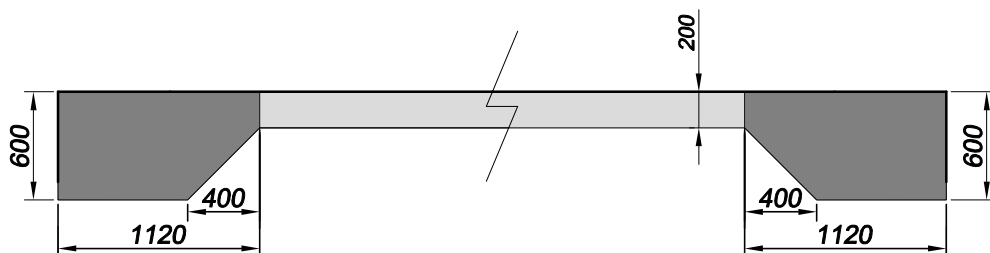
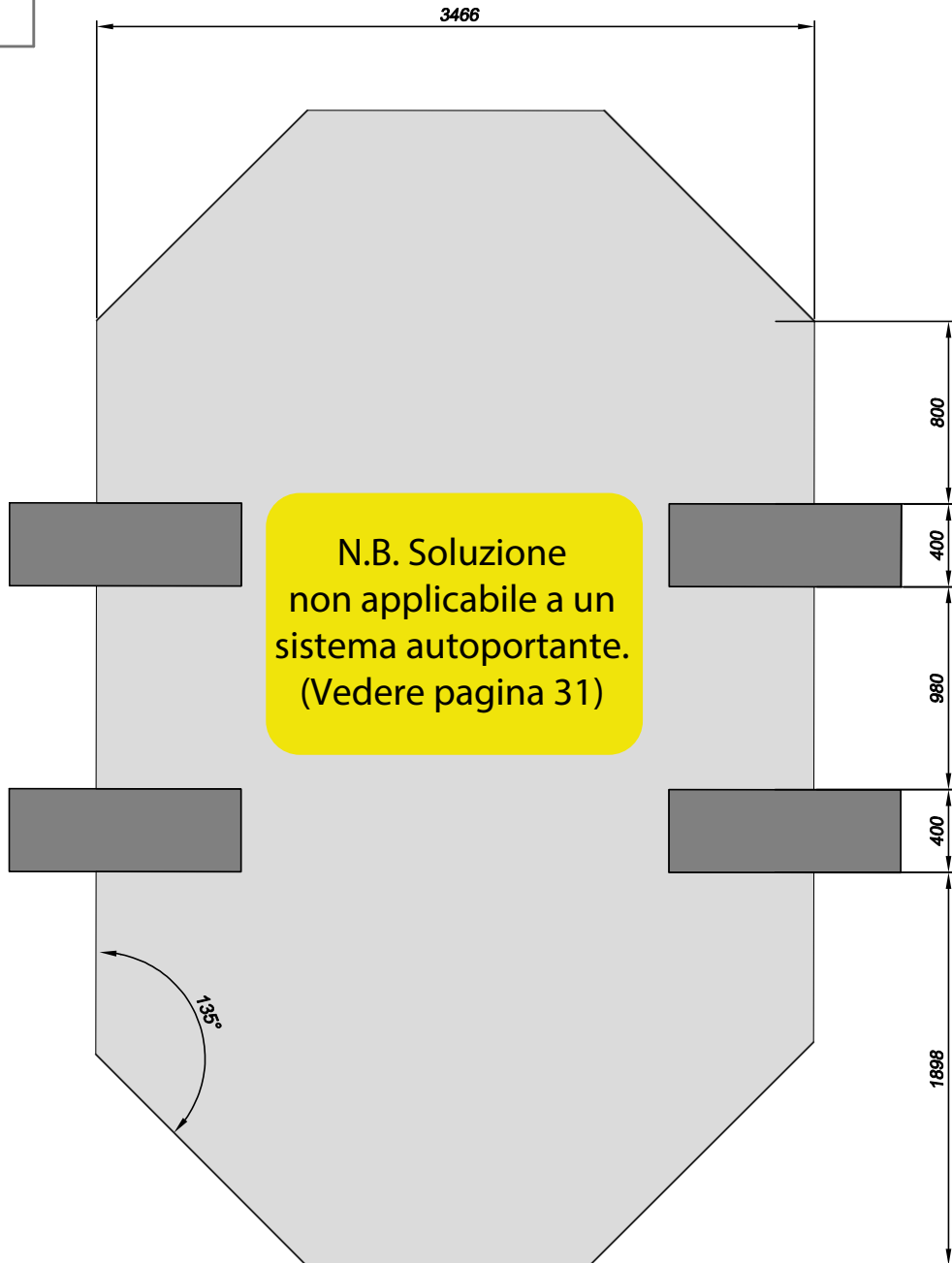
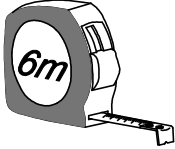

**(PL) Podłoże**

**(GB) Ground**

**(D) Untergrund**

**(FR) Terrain**

**(IT) Suolo**

**(RU) база**



**(PL)** Powierzchnia musi być twarda, płaska i wypoziomowana. Zastosuj piasek stabilizowany cementem.

**(FR)** Le terrain doit être rigoureusement plat, dur et de niveau. Utilisez le sable stabilisé au ciment.

**(GB)** The surface must be firm, flat and leveled. Use cement-stabilized sand.

**(IT)** La superficie deve essere solida, piana e livellata. Utilizzare sabbia stabilizzata con cemento.

**(D)** Der Untergrund muss fest, eben und nivelliert sein. Verwenden Sie zementstabilisierten Sand.

**(RU)** Поверхность должна быть твердой, плоской и равномерной. использовать песок, стабилизированный цементом.

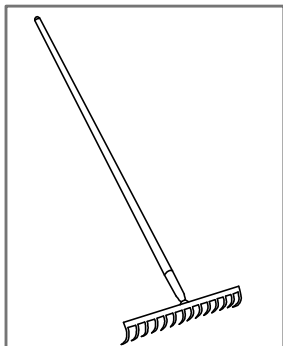
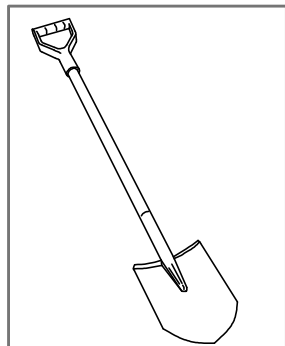

[mm]

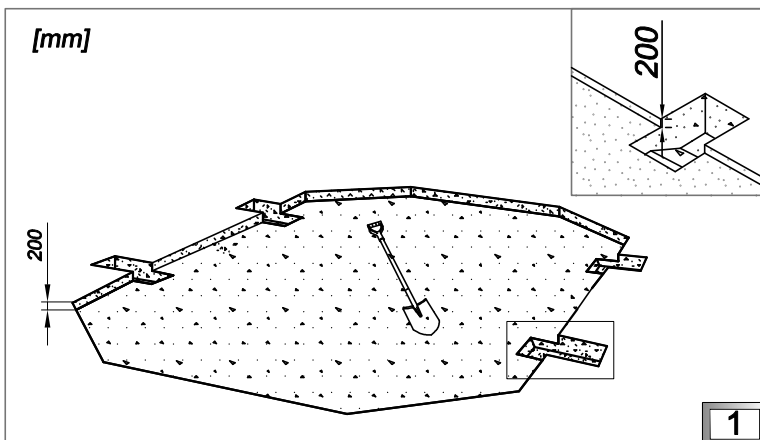

1

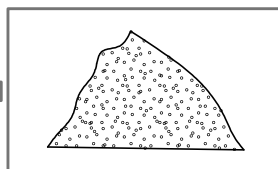
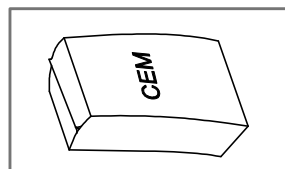
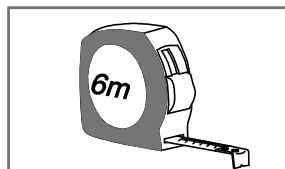

**N.B. Soluzione non applicabile a un sistema autoportante. (Vedere pagina 31)**

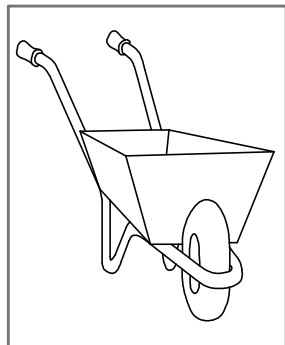
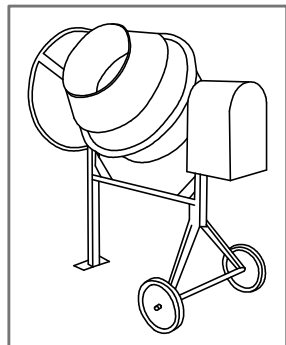

[mm]

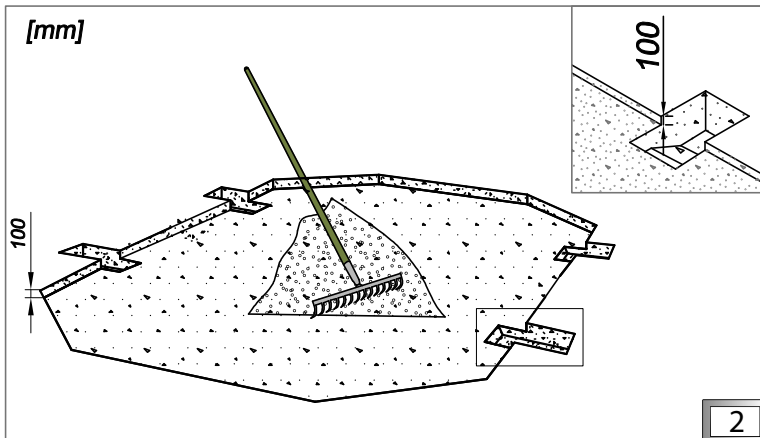

2

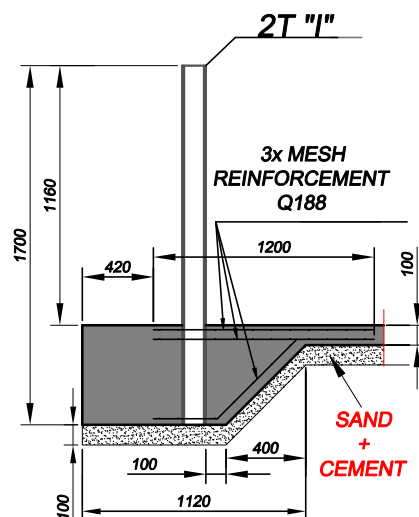
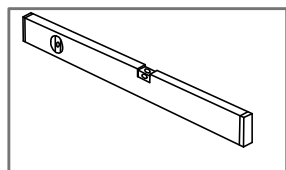
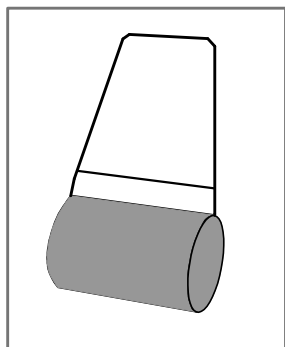
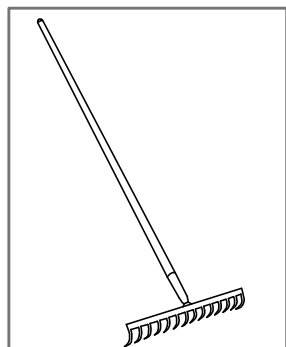



**PL** Podłoże

**GB** Ground

**D** Untergrund

**FR** Terrain

**IT** Suolo

**RU** база



**PL** Powierzchnia musi być twarda, płaska i wypoziomowana. Pamiętaj o wykonaniu zbrojenia wylewki betonowej.  
**FR** Le terrain doit être rigoureusement plat, dur et de niveau. Préparez l'armature de la dalle en béton.  
**GB** The surface must be firm, flat and leveled. Remember about reinforcement of concrete screed.  
**IT** La superficie deve essere solida, piana e livellata. Ricordati di eseguire l'armatura per il calcestruzzo.  
**D** Der Untergrund muss fest, flach und eben sein. Vergessen Sie nicht den Betonestrich zu bewehren.  
**RU** Поверхность должна быть твердой, плоской и равномерной. Применить цемент для фундаментов.

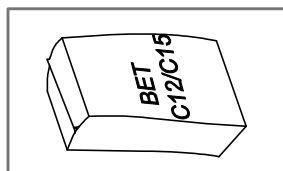

A-IIIIN (B500SP) Q188

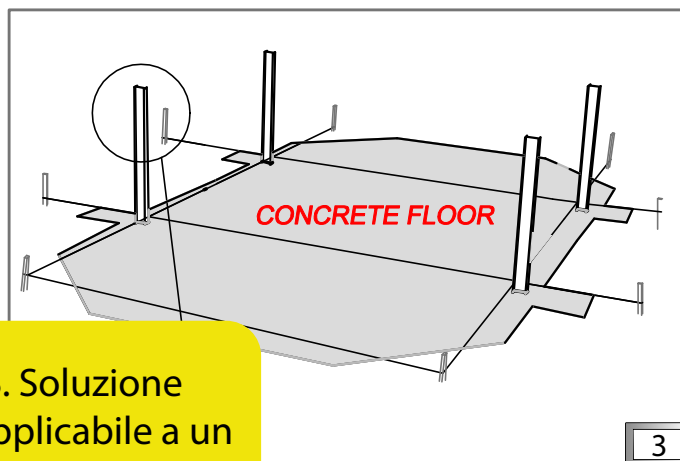
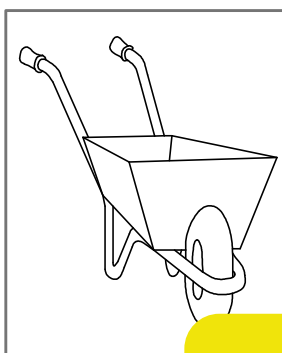
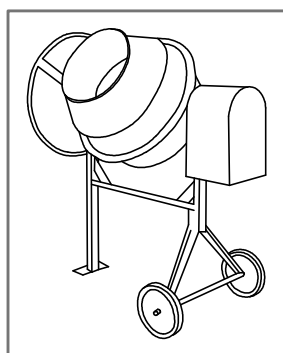
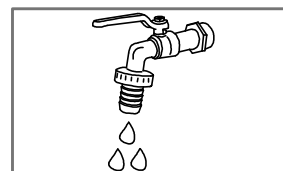
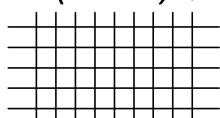

**N.B. Soluzione non applicabile a un sistema autoportante. (Vedere pagina 31)**

3

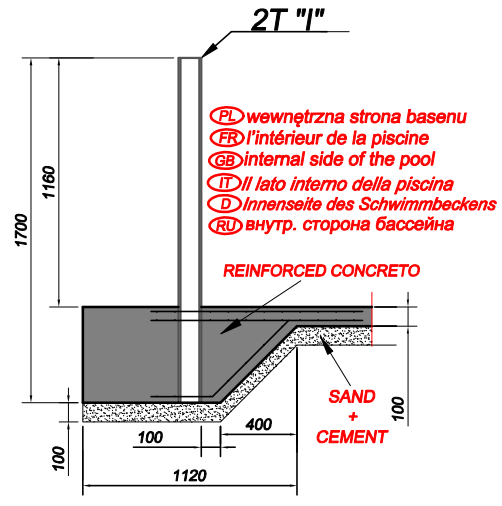
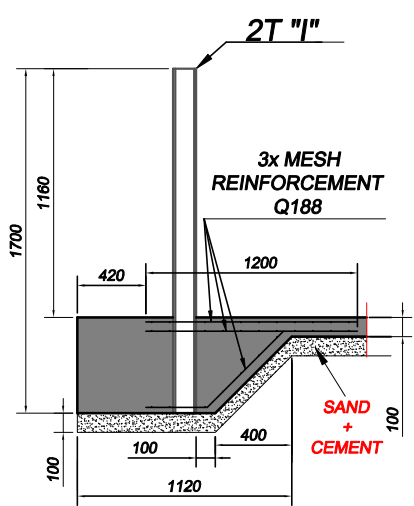
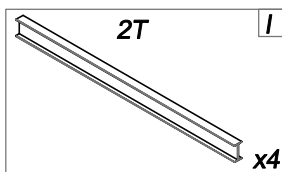
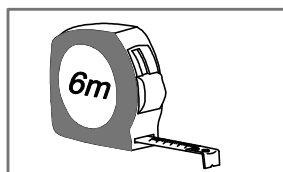
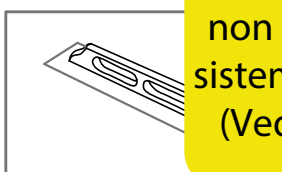
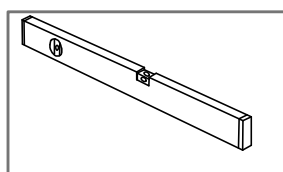

PL Podłoże

GB Ground

D Untergrund

FR Terrain

IT Suolo

RU база



PL Schemat rozmieszczenia słupków 2T (I) oraz przygotowania wylewki betonowej.

FR Le schéma de la disposition des poteaux métalliques 2T (I) et de la préparation de la dalle en béton.

GB Scheme of steel bearers 2T (I) arrangement, preparing concrete base.

IT Schematica dei pilastri 2T (I) e della preparazione di calcestruzzo.

D Schematische Darstellung von 2T - Säulen (I) und Vorbereitung des Betonestriches.

RU Схема размещения стоек 2T (I) и подготовки бетонного основания.

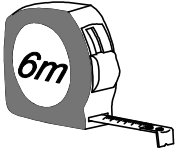

[mm]

N.B. Soluzione non applicabile a un sistema autoportante. (Vedere pagina 31)

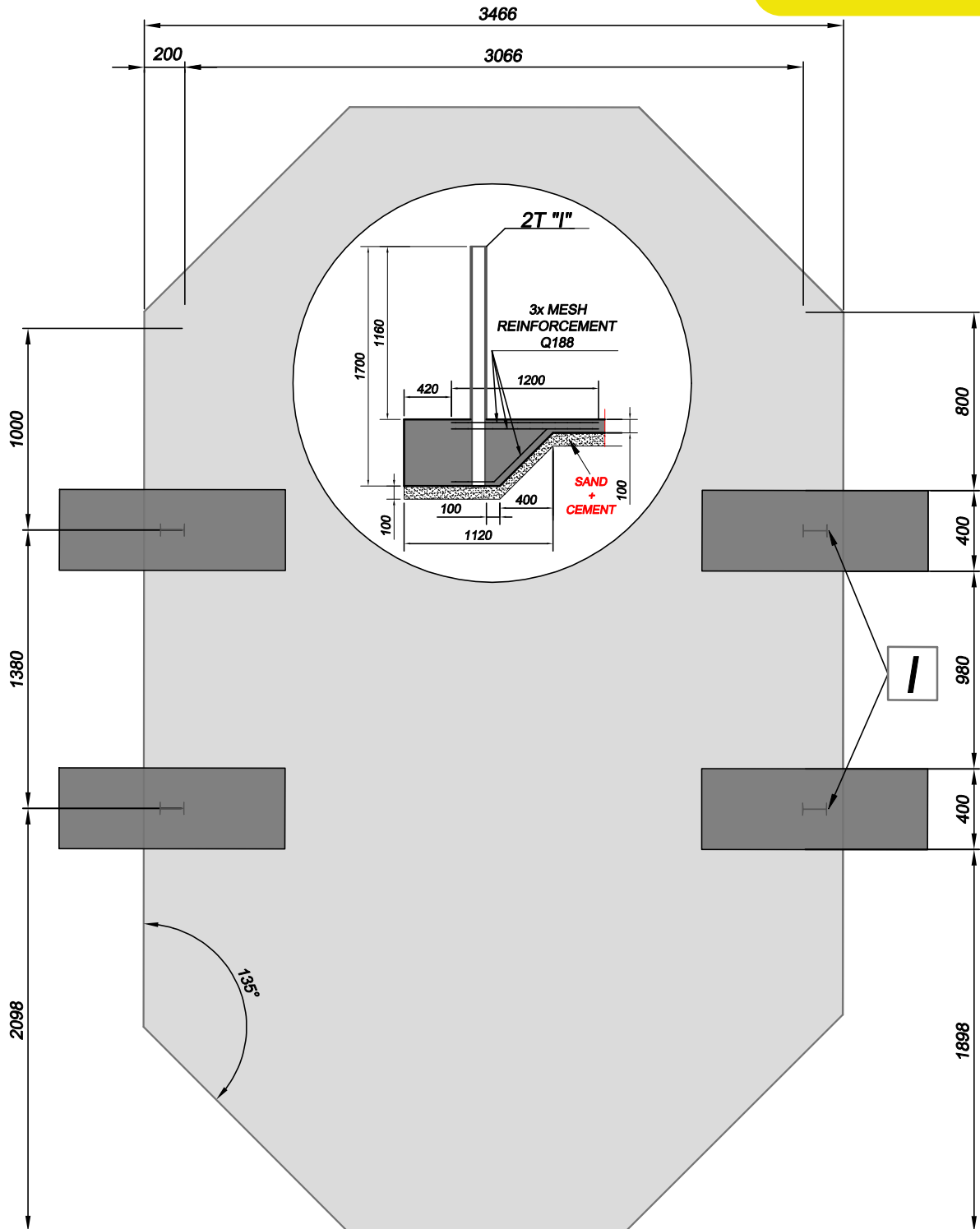



**(PL)** Struktura drewniana

**(GB)** Wooden structure

**(D)** Holzstruktur

**(FR)** La structure bois

**(IT)** Struttura in legno

**(RU)** Деревянная структура



**(PL)** Schemat rozmieszczenia warstw struktury. Ułożenie warstwy I.

**(FR)** Le schéma de la disposition des couches de la structure. La pose de la couche I.

**(GB)** Arrangement of structure's layers. Putting layer I.

**(IT)** Schematica degli strati della struttura. Posare lo strato I.

**(D)** Schema der Anordnung von Strukturschichten. Auflegen der I-Schichte.

**(RU)** Схема размещения слоев структуры. Укладка I слоя.

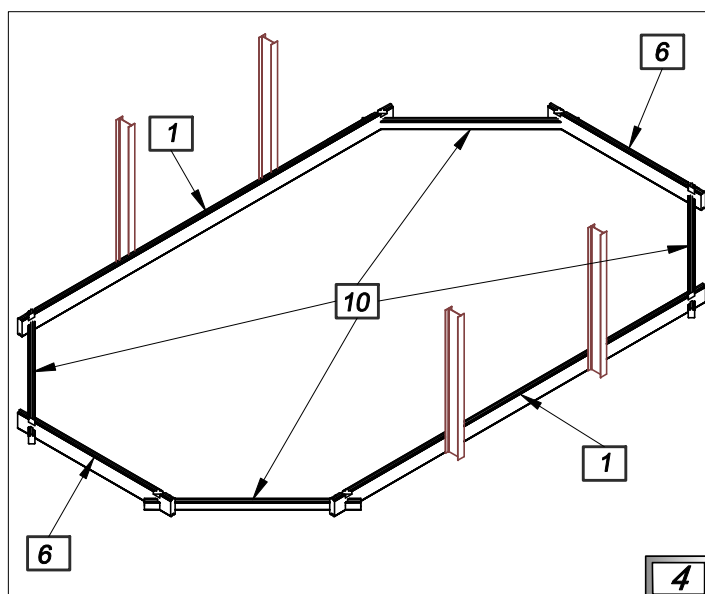
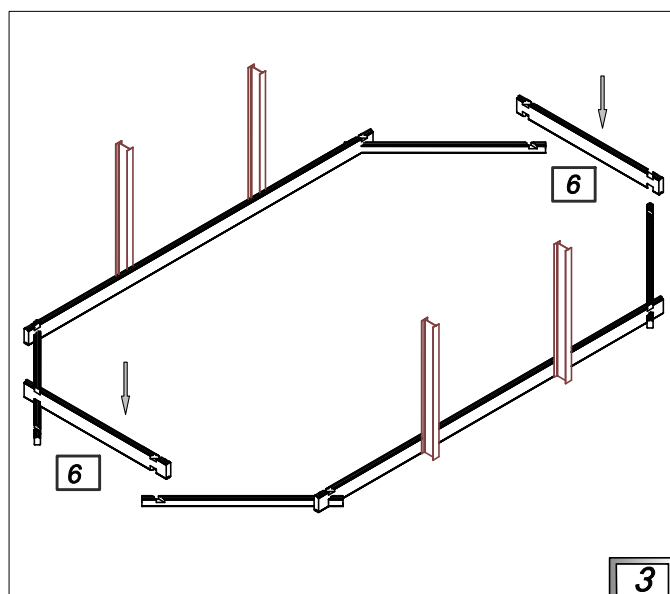
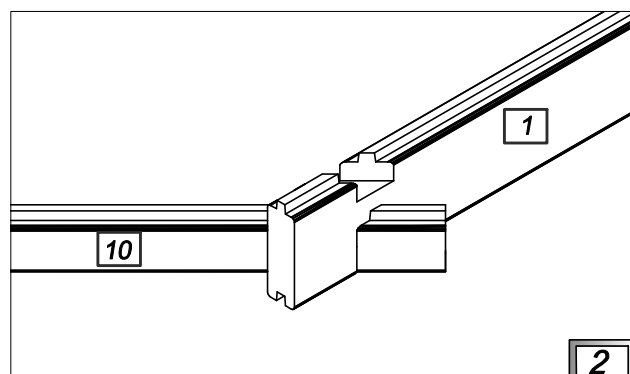
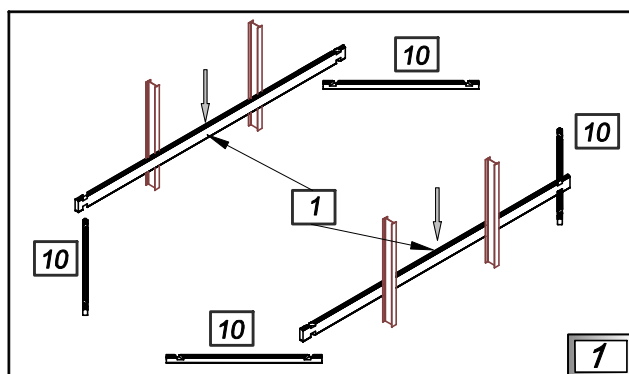
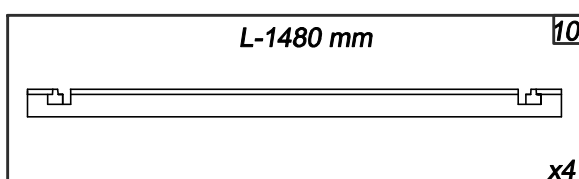
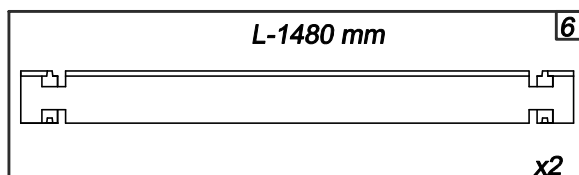
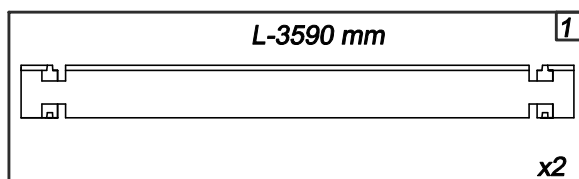
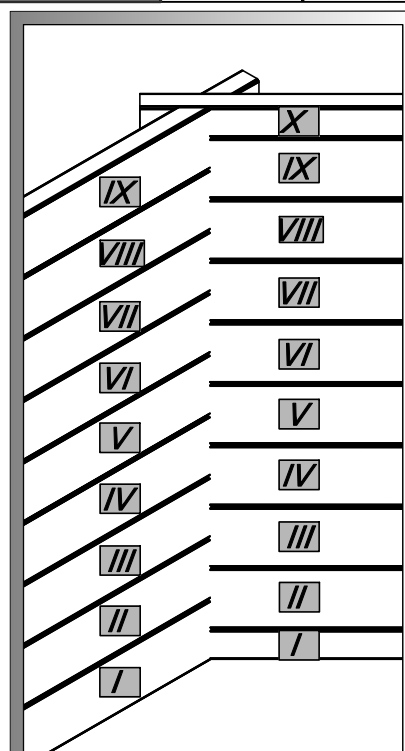

**(PL) Struktura drewniana**

**(GB) Wooden structure**

**(D) Holzstruktur**

**(FR) La structure bois**

**(IT) Struttura in legno**

**(RU) Деревянная структура**



**(PL)** Po ułożeniu każdej z warstw sprawdź przekątne D według rysunku.

**(FR)** Vérifiez les diagonales "D" après la pose de chaque tour.

**(GB)** After putting each layer check D diagonals according to the drawing.

**(IT)** Dopo la posa di ogni strato bisogna controllare diagonali D, secondo il disegno.

**(D)** Nach Verlegen von jeder Schicht kontrollieren Sie D-Diagonale nach Schema.

**(RU)** После укладки каждого слоя проверить диагонали D согласно рисунку.

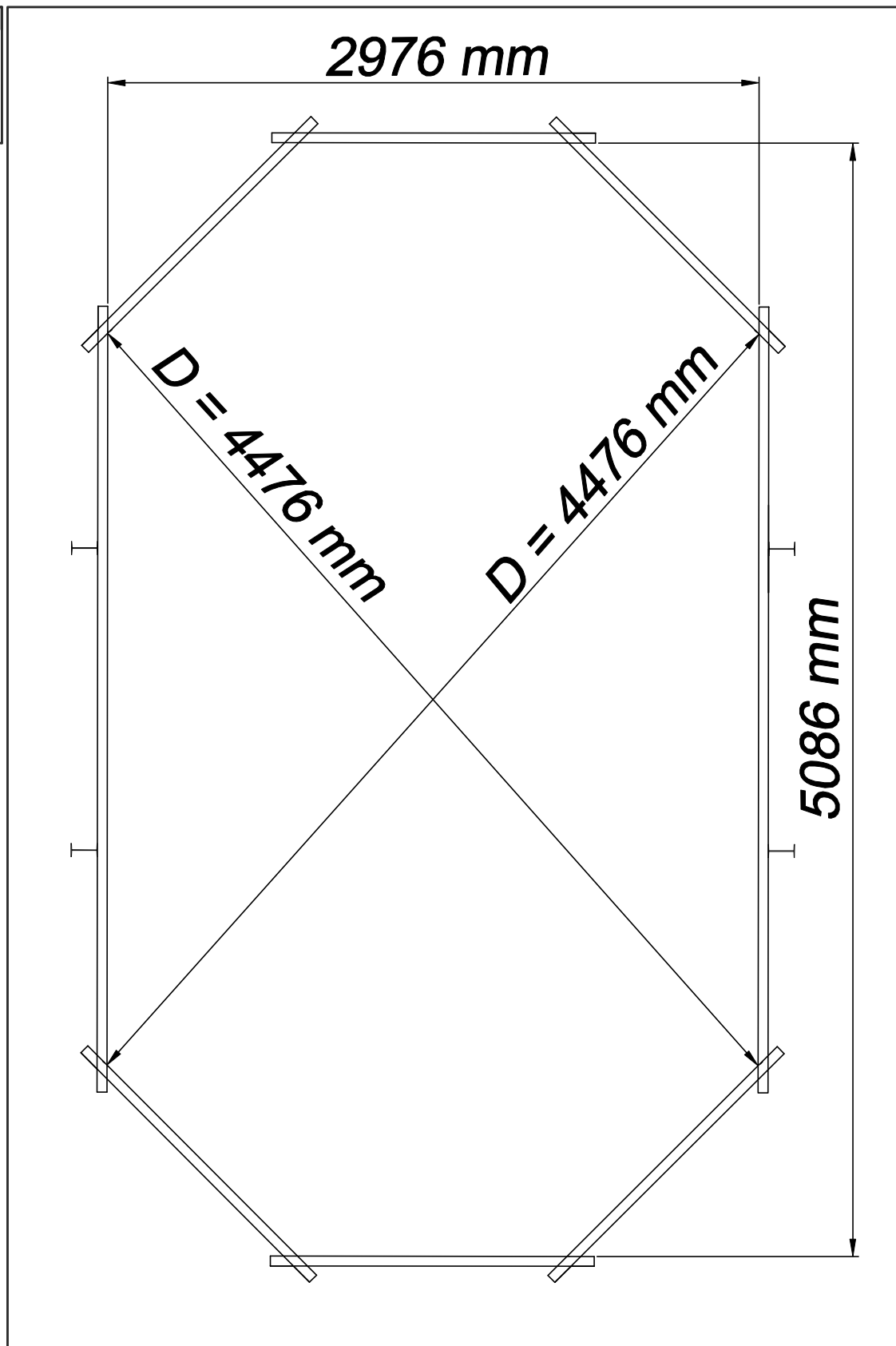
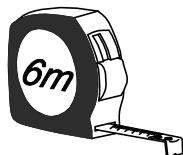

**(PL)** Struktura drewniana

**(GB)** Wooden structure

**(D)** Holzstruktur

**(FR)** La structure bois

**(IT)** Struttura in legno

**(RU)** Деревянная структура



**(PL)** Ułożenie kolejnych warstw. Sprawdzaj przekątną D po każdej ułożonej warstwie.

**(FR)** L'assemblage des couches suivantes. Vérifiez les diagonales "D" après la pose de chaque tour.

**(GB)** Putting next layers. Check D diagonals every layer.

**(IT)** La messa degli strati successivi. Trova la diagonale D dopo ogni strato.

**(D)** Verlegen der nachfolgenden Schichten. Nach Verlegen von jeder Schicht kontrollieren Sie die D-Diagonale.

**(RU)** Укладка очередных слоев. Проверять диагональ D после каждой укладки слоя.

L-3590 mm

1

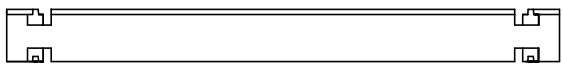

x2

L-1480 mm

6

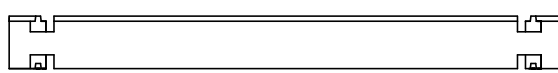

x6

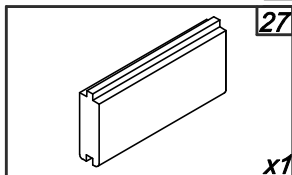
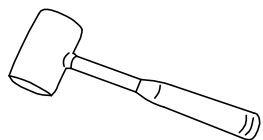

27

x1

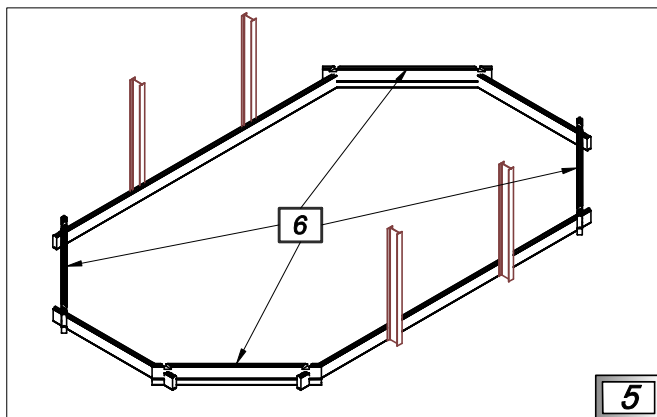
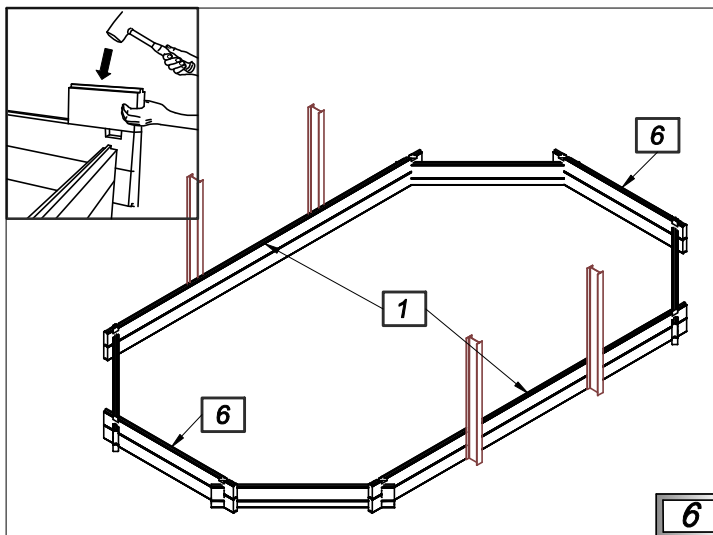

5

L-3590 mm

1

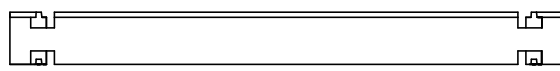

x2

L-1480 mm

6

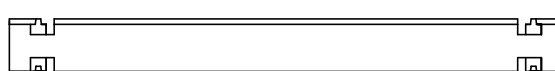

x5

L-1480 mm

8

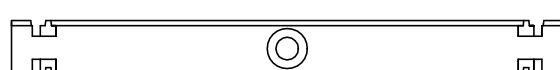

x1

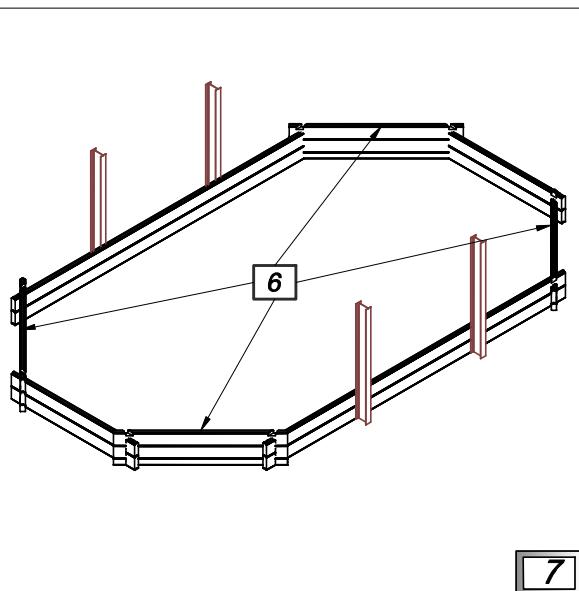
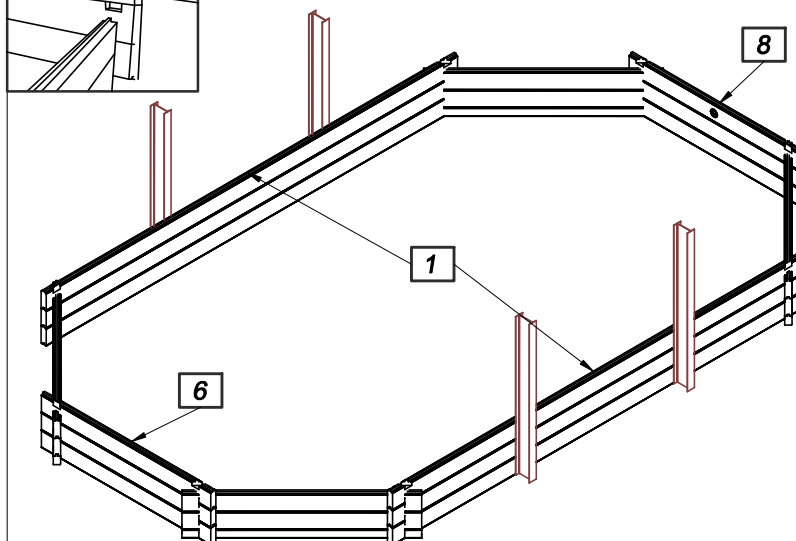
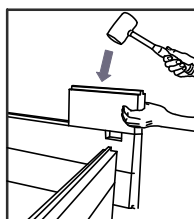

7

///

8

**(PL)** Struktura drewniana

**(GB)** Wooden structure

**(D)** Holzstruktur

**(FR)** La structure bois

**(IT)** Struttura in legno

**(RU)** Деревянная структура



**(PL)** Ułożenie kolejnych warstw. Sprawdzaj przekątną D po każdej ułożonej warstwie.

**(FR)** L'assemblage des couches suivantes. Vérifiez les diagonales "D" après la pose de chaque tour.

**(GB)** Putting next layers. Check D diagonals every layer.

**(IT)** La messa degli strati successivi. Trova la diagonale D dopo ogni strato.

**(D)** Verlegen der nachfolgenden Schichten. Nach Verlegen von jeder Schicht kontrollieren Sie die D-Diagonale.

**(RU)** Укладка очередных слоев. Проверять диагональ D после каждой укладки слоя.

**IV-VII**

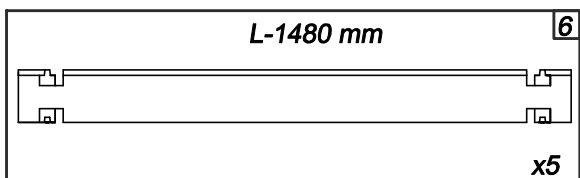
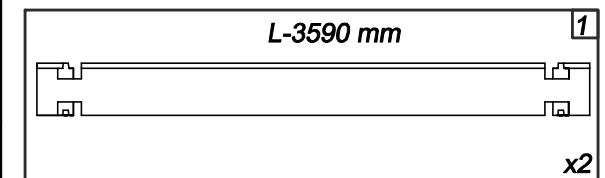
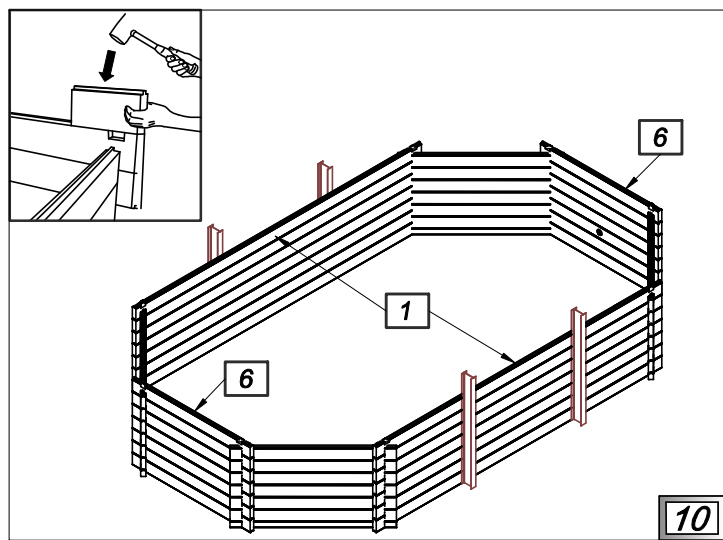
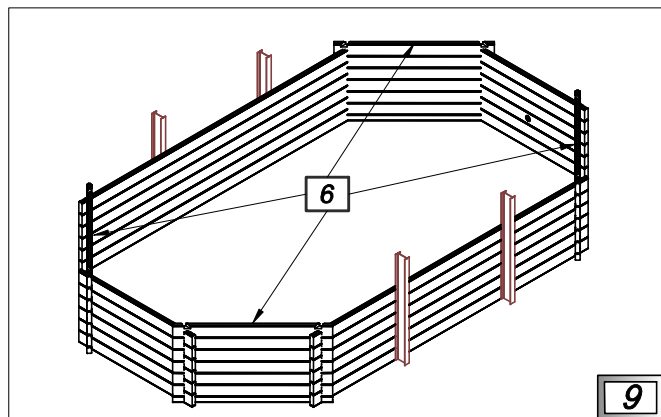
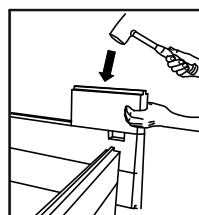
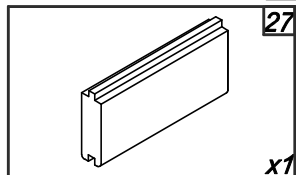
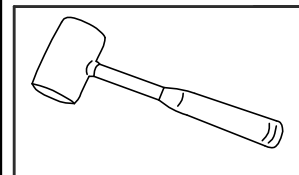
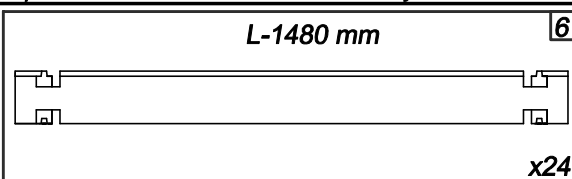
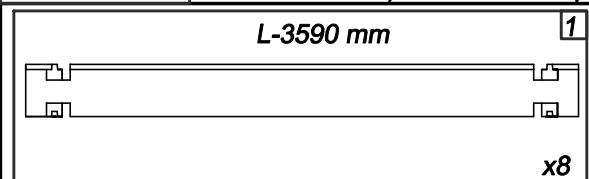

**VIII**

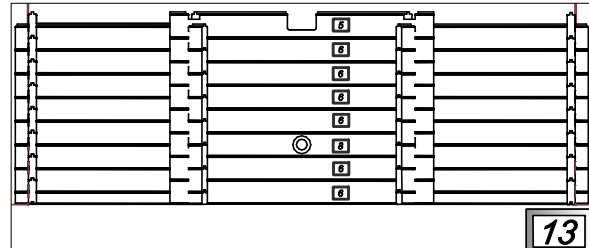
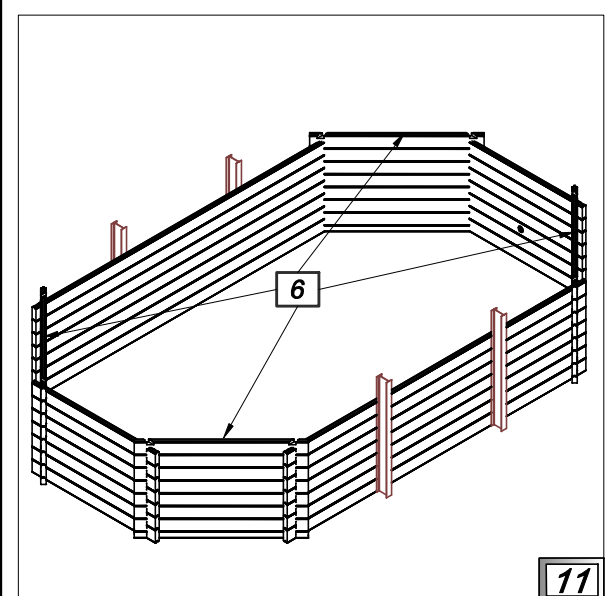
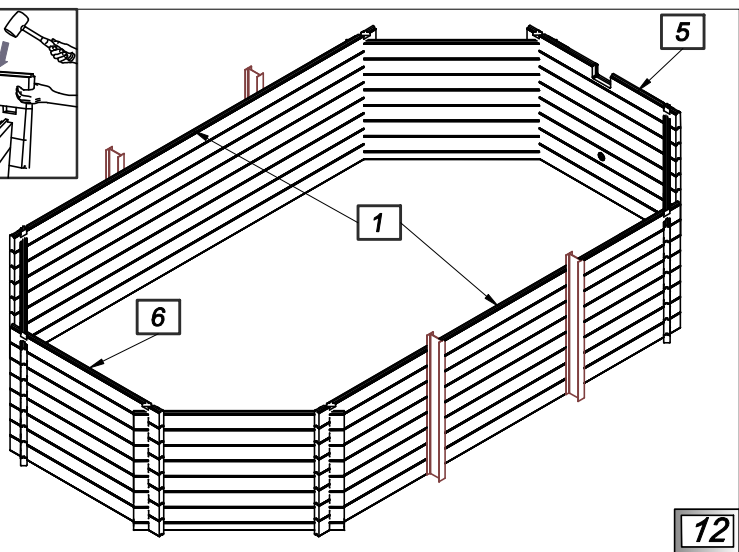
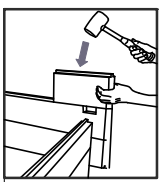
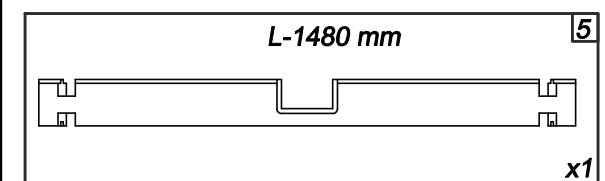

**(PL)** Struktura drewniana

**(GB)** Wooden structure

**(D)** Holzstruktur

**(FR)** La structure bois

**(IT)** Struttura in legno

**(RU)** Деревянная структура



**(PL)** Ułożenie kolejnych warstw. Zamontuj skimmer.

**(FR)** La pose des couches suivantes. Montez le skimmer.

**(GB)** Laying next layers. Mount a skimmer.

**(IT)** La disposizione degli strati successivi. Montare lo skimmer.

**(D)** Auflegen der weiteren Schichten. Bauen Sie den Skimmer ein.

**(RU)** Укладка очередных слоев. Закрепить скиммер.

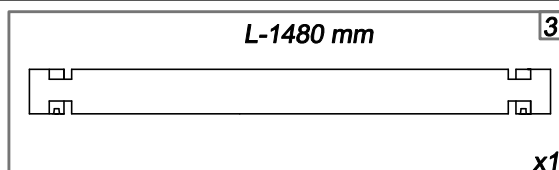
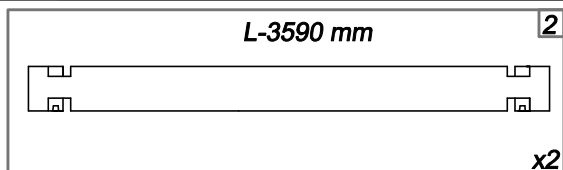

**IX**

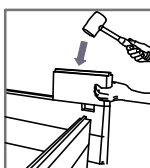
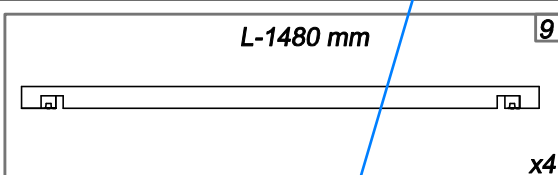
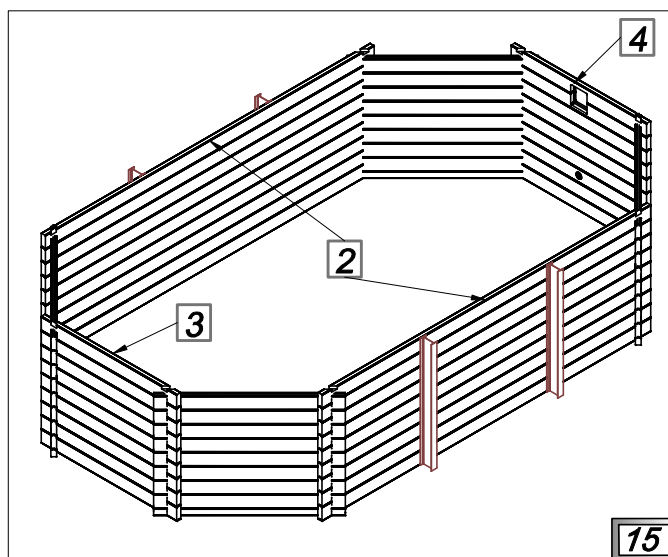
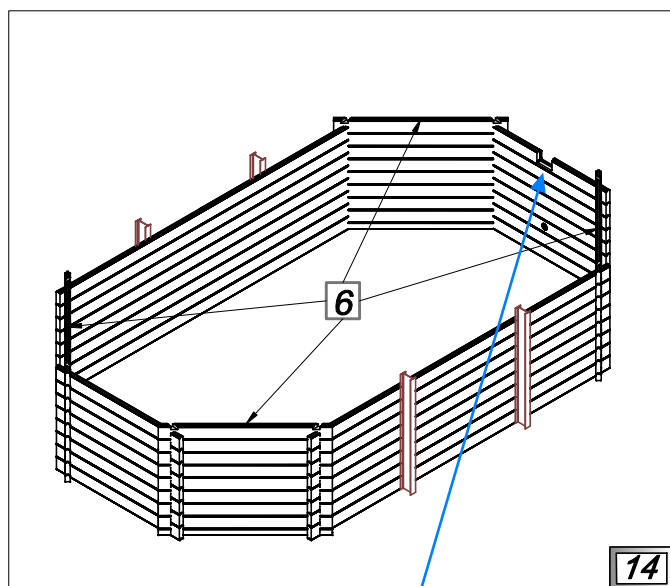
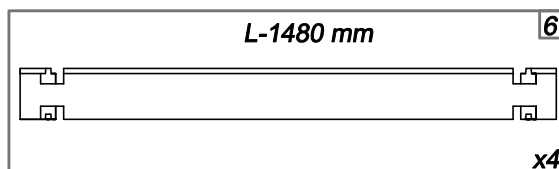
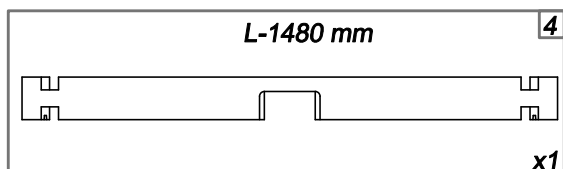

**X**

**ATTENZIONE!**  
Posizionare lo SKIMMER  
prima di inserire la  
semitavola superiore.  
Vedi le istruzioni di  
montaggio degli accessori  
per tutti i dettagli.

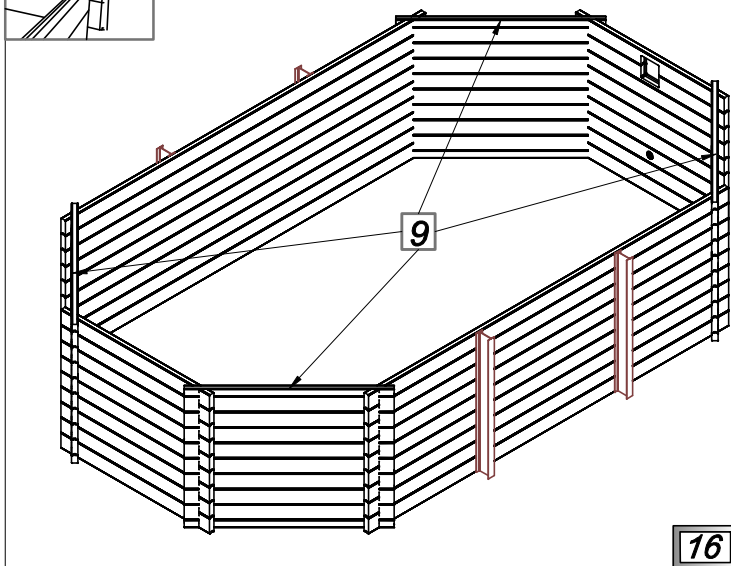



**PL** Struktura drewniana

**GB** Wooden structure

**D** Holzstruktur

**FR** La structure bois

**IT** Struttura in legno

**RU** Деревянная структура



- PL** Montaż wspornika schodów (7).
- FR** Le montage du renfort d'escalier (7).
- GB** Installation of stairs support (7).
- IT** Montaggio delle scale a sbalzo (7).
- D** Montage von Treppenstützen(7).
- RU** Монтаж кронштейна лестницы (7).

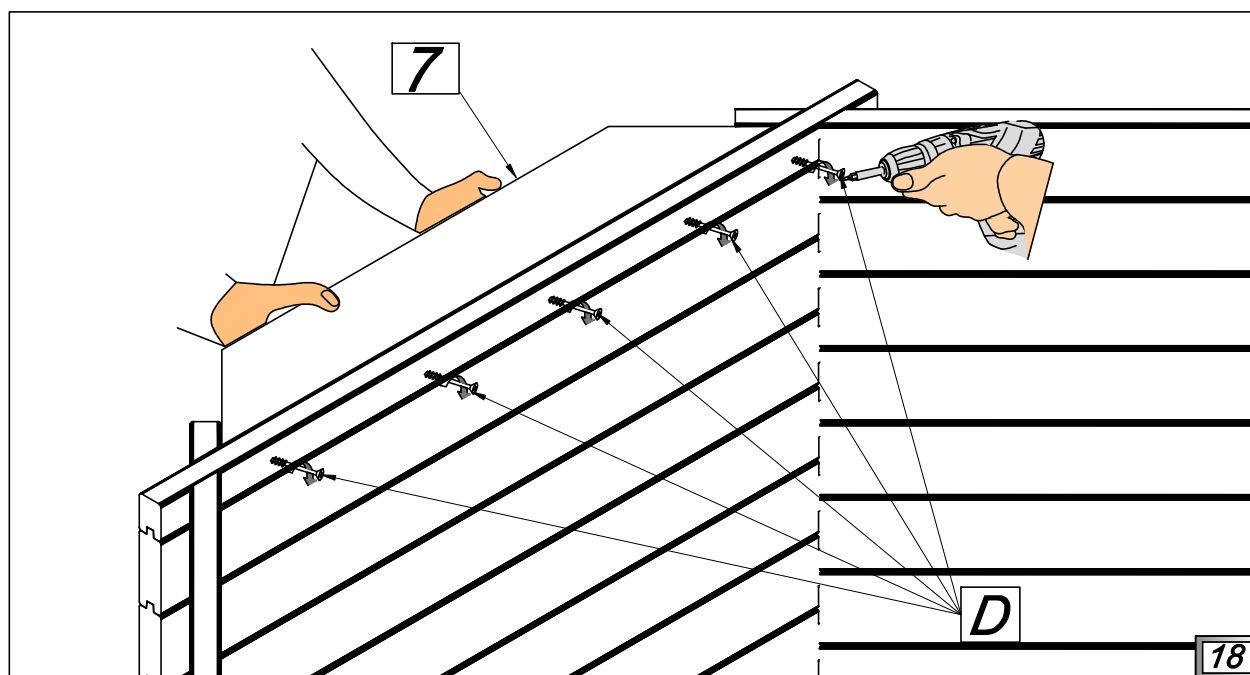
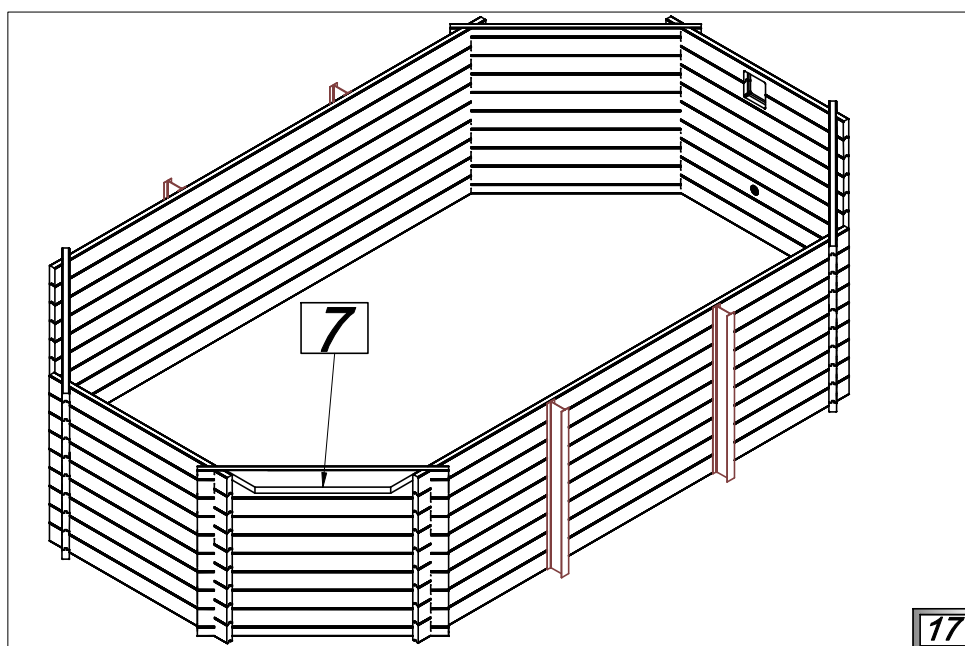
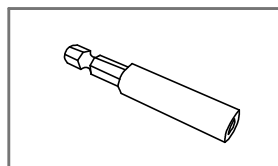
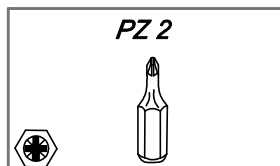
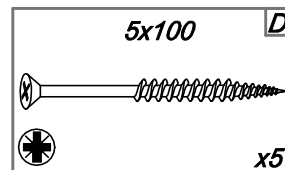
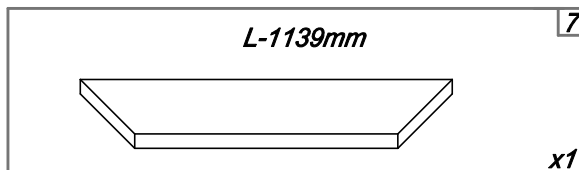
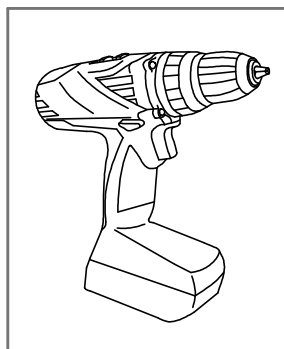

**PL** Struktura drewniana

**GB** Wooden structure

**D** Holzstruktur

**FR** La structure bois

**IT** Struttura in legno

**RU** Деревянная структура



**PL** Rozłożenie wsporników pionowych (26) oraz konsol (18) według schematu.

**FR** La disposition des renforts verticaux (26) et des supports des margelles (18) d'après le schéma.

**GB** Arrangement of vertical supports (26) and consoles (18) according to the drawing.

**IT** La distribuzione degli sbalzi verticali (26) e delle console (18), secondo lo schema.

**D** Verteilung der vertikalen Stützen (26) und Konsolen (18) nach Schema.

**RU** Размещение вертикальных кронштейнов (26) и консолей (18) согласно схеме.

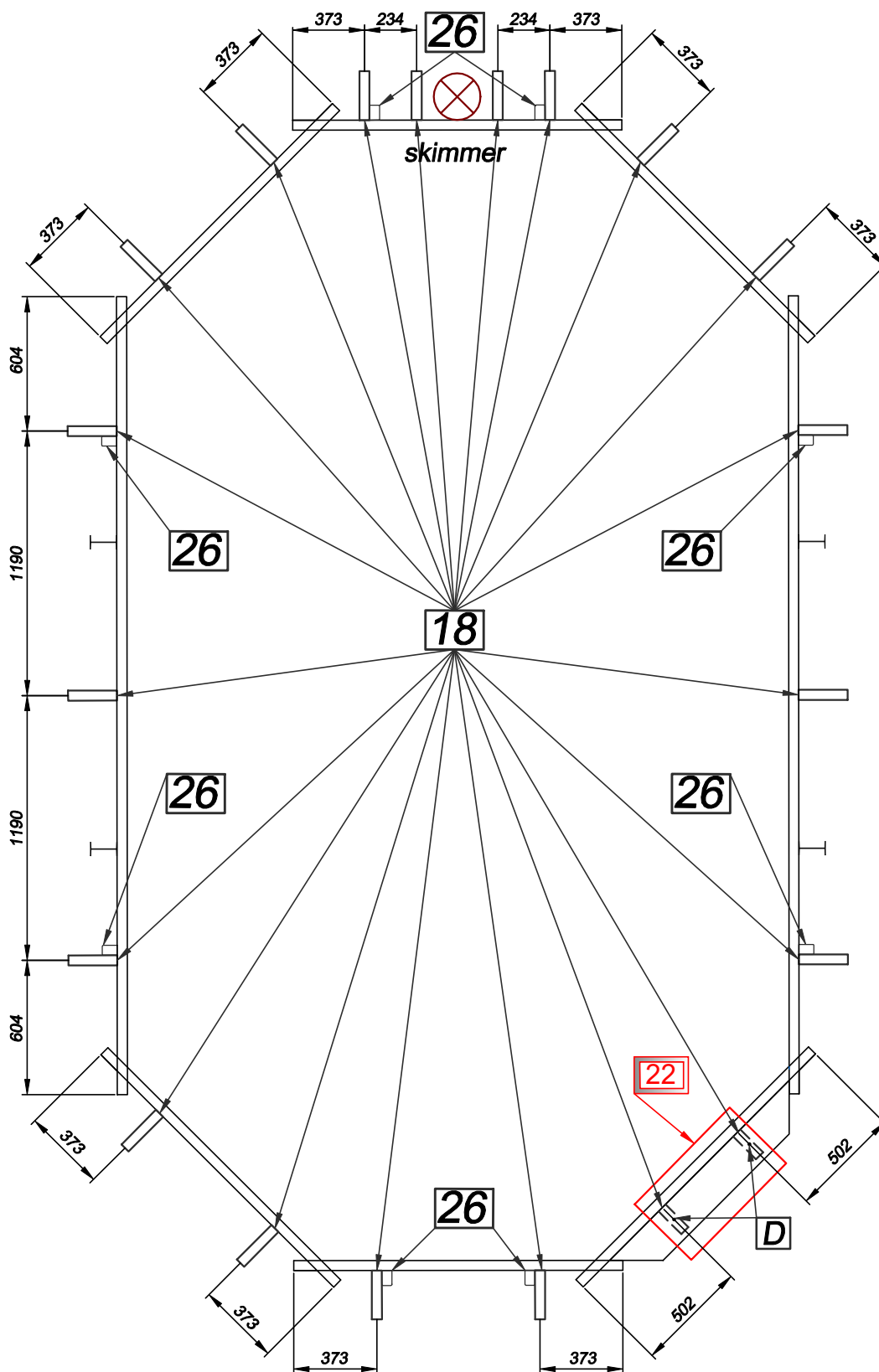

**PL** Struktura drewniana

**GB** Wooden structure

**D** Holzstruktur

**FR** La structure bois

**IT** Struttura in legno

**RU** Деревянная структура



**PL** Montaż konsol (18). Konsole montowane pod wspornikiem schodów (7) według rysunku 22.

**FR** Le montage des supports des margelles (18). Montez les supports des margelles sous un renfort d'escalier (7) d'après le dessin 22.

**GB** Installation of consoles (18). Consoles under ladder support (7) installed according to the drawing 22.

**IT** Il montaggio di console (18). Console sono montate sotto lo sbalzo della scala (7), come mostrato sul disegno 22.

**D** Konsolenmontage (18). Die Konsolen werden unter den Treppenstützen (7) nach Abb 22 montiert.

**RU** Монтаж консолей (18). Консоли устанавливаются под кронштейном лестницы (7) согласно рис. 22.

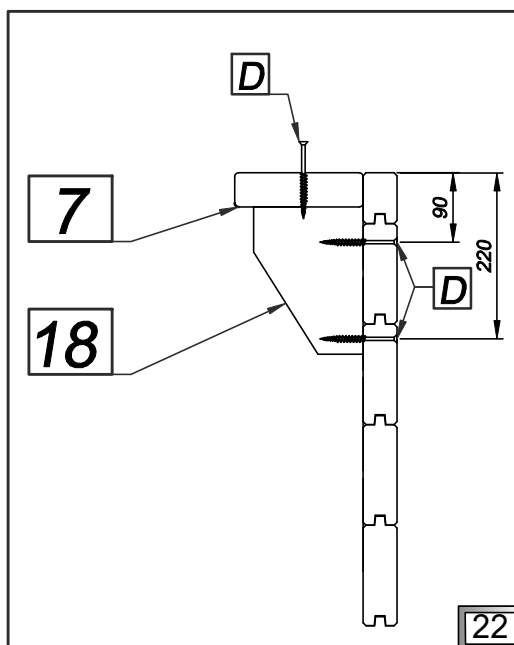
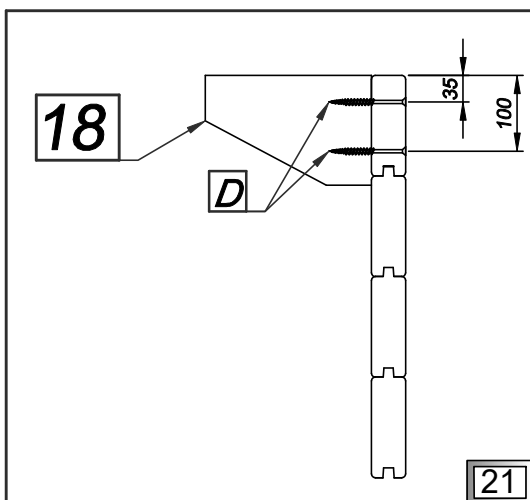
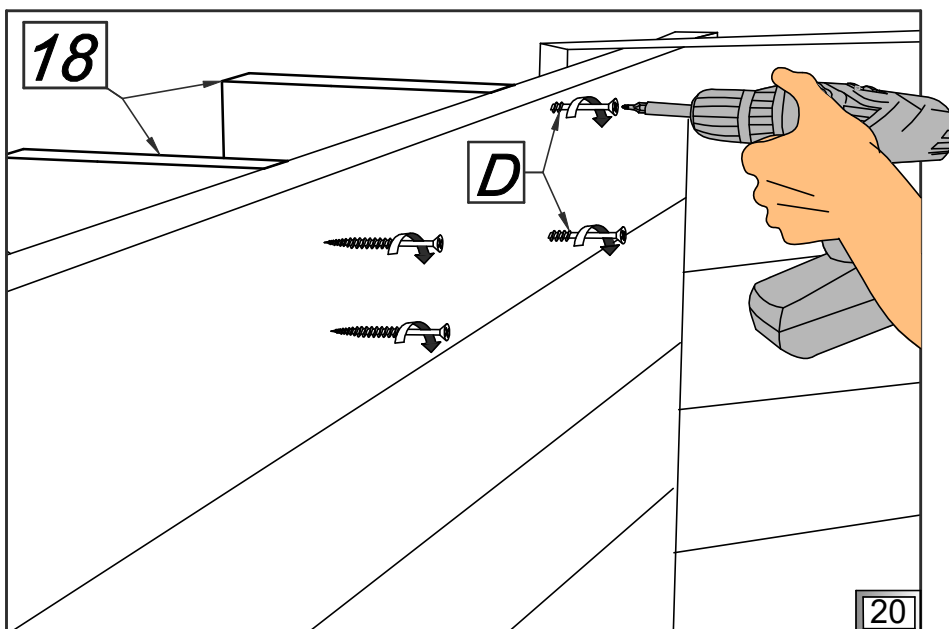
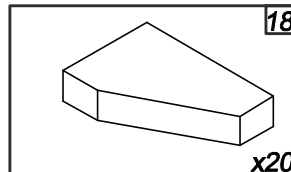
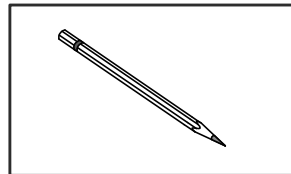
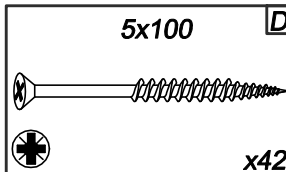
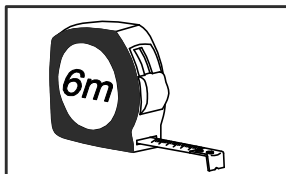
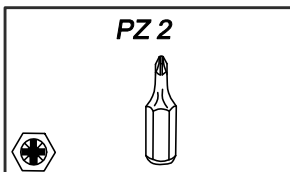
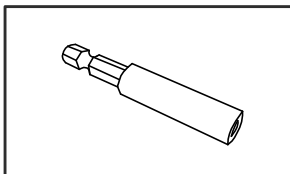
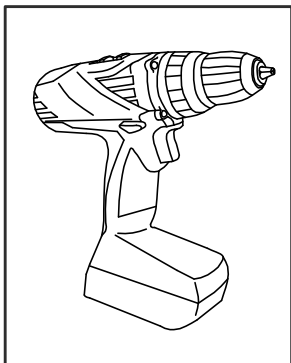

**PL** Struktura drewniana

**GB** Wooden structure

**D** Holzstruktur

**FR** La structure bois

**IT** Struttura in legno

**RU** Деревянная структура



**PL** Montaż wsporników pionowych (26). Wkręty rozmieszczaj według rysunku 24.

**FR** Le montage des renforts verticaux (26). La disposition des vis d'après le dessin 24.

**GB** Installation of vertical supports (26). Arrange screws according to the drawing 24.

**IT** Montaggio degli sbalzi verticali (26). Mettere viti secondo il disegno 24.

**D** Montage von vertikalen Stützen (26). Schrauben sind nach Abb 24 angebracht.

**RU** Монтаж вертикальных кронштейнов (26). Винты размещаются согласно рис. 24.

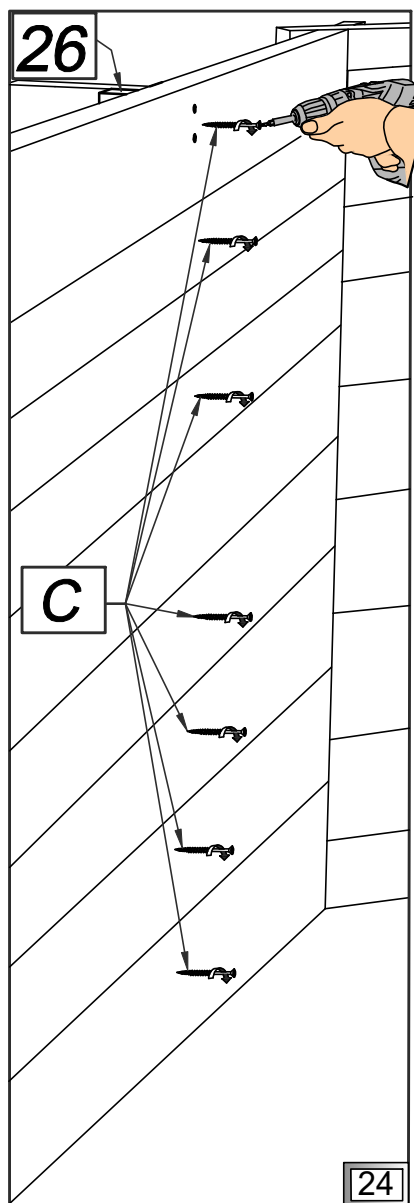
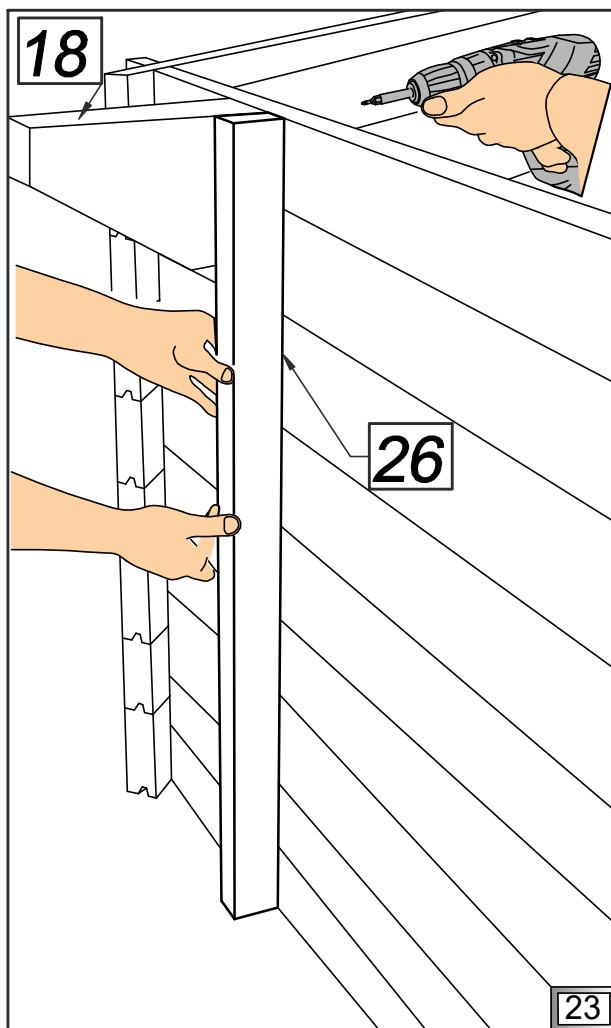
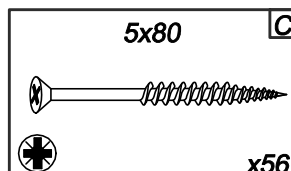
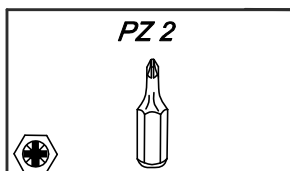
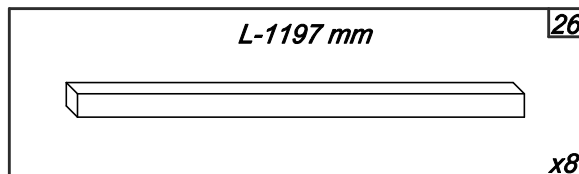
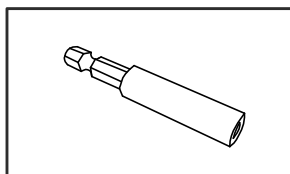
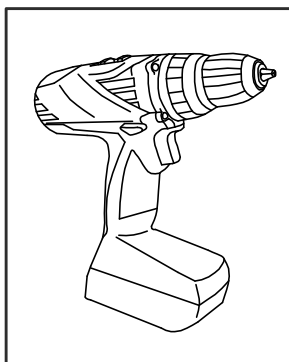

**(PL)** Struktura drewniana

**(GB)** Wooden structure

**(D)** Holzstruktur

**(FR)** La structure bois

**(IT)** Struttura in legno

**(RU)** Деревянная структура



**(PL)** Maskowanie słupków metalowych 2T (I) maskownicami (24,25).

**(FR)** La fixation des caches (24,25) pour les poteaux métalliques 2T (I).

**(GB)** Covering steel bars 2T (I) with masking elements (24,25).

**(IT)** Mascherare i pilastri di metallo 2T (I) con i mascherini (24,25).

**(D)** Verdeckung von 2T-Metallsäulen (I) mit Abdeckungen (24,25).

**(RU)** Маскировка металлических стоек 2Т (I) маскировочными экранами (24,25).

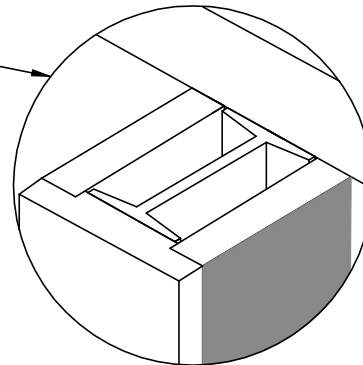
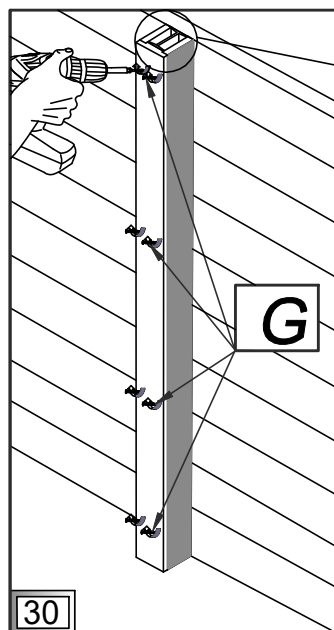
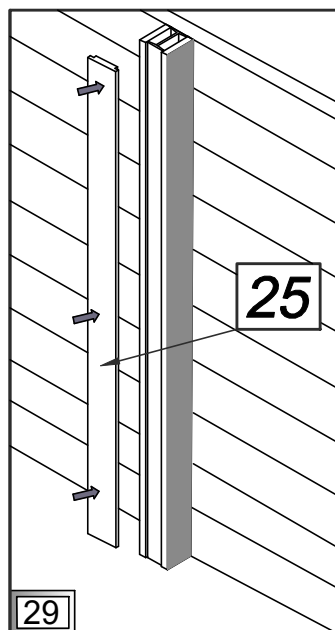
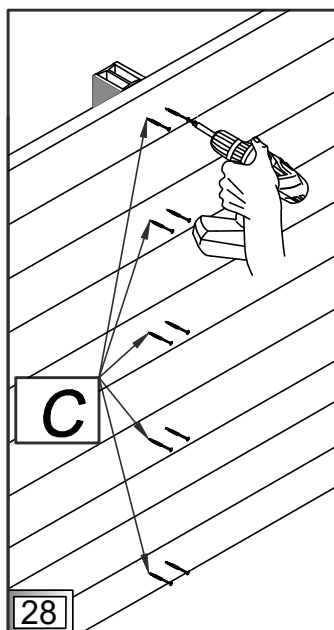
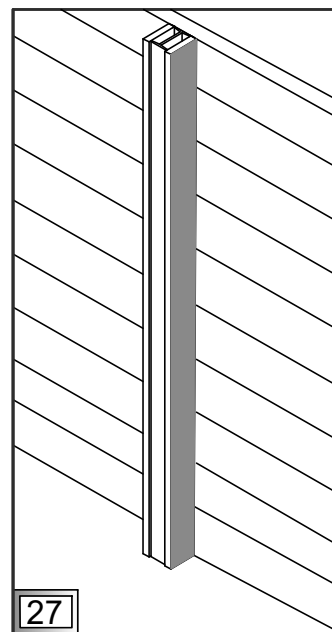
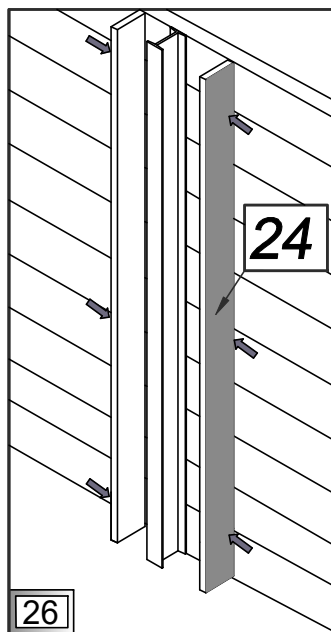
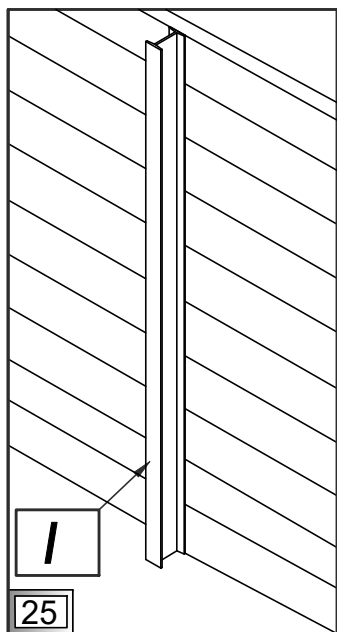
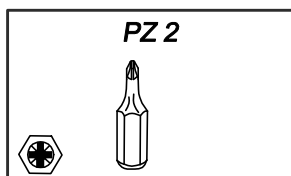
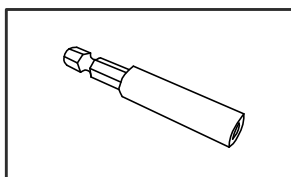
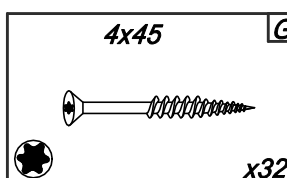
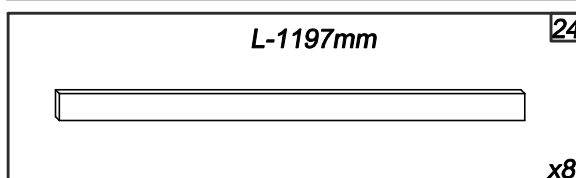
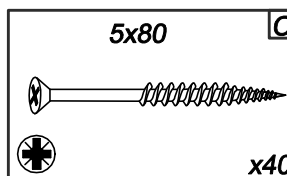
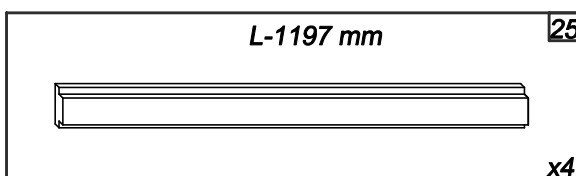
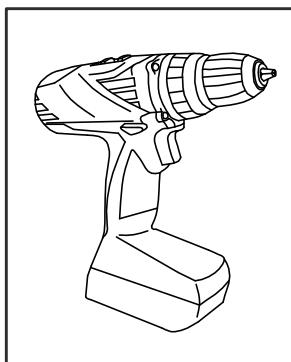



**(PL)** Struktura drewniana

**(GB)** Wooden structure

**(D)** Holzstruktur

**(FR)** La structure bois

**(IT)** Struttura in legno

**(RU)** Деревянная структура



- (PL)** Montaż maskownicy 57 mm (23).
- (FR)** Le montage des caches 57 mm (23).
- (GB)** Installation of the masking element 57 mm (23).
- (IT)** Montaggio del mascherino 57 mm (23).
- (D)** Montage der Abdeckung 57 mm (23).
- (RU)** Монтаж маскировочного экрана 57 мм (23).

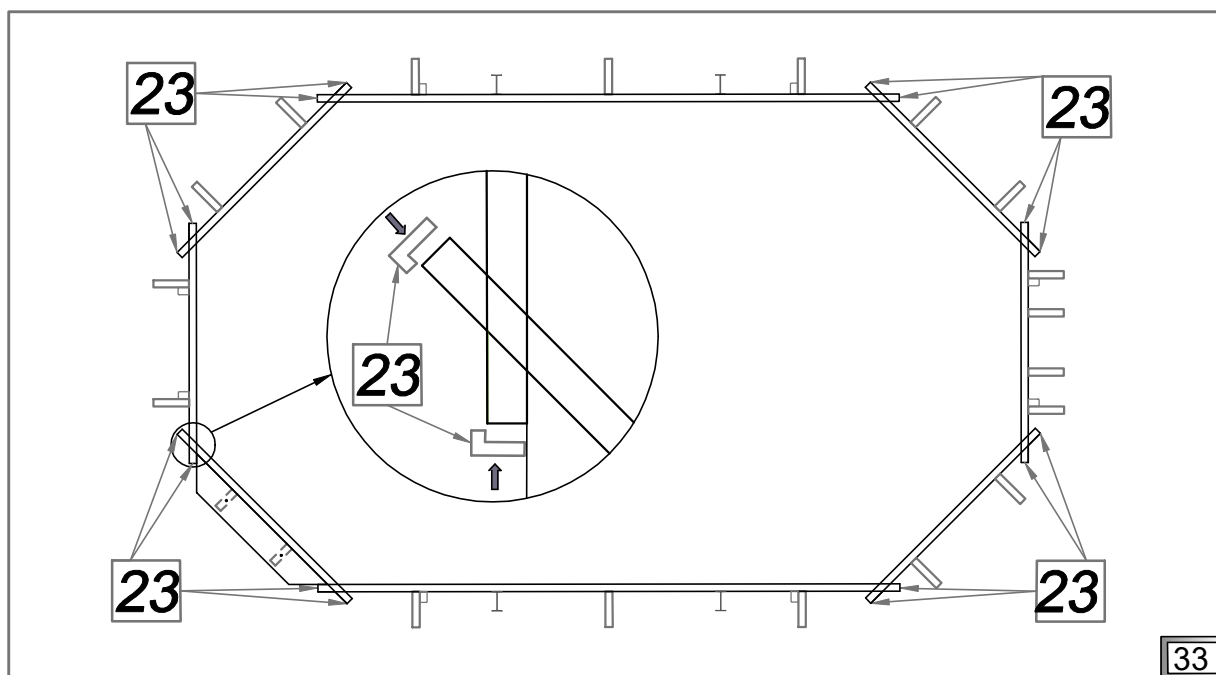
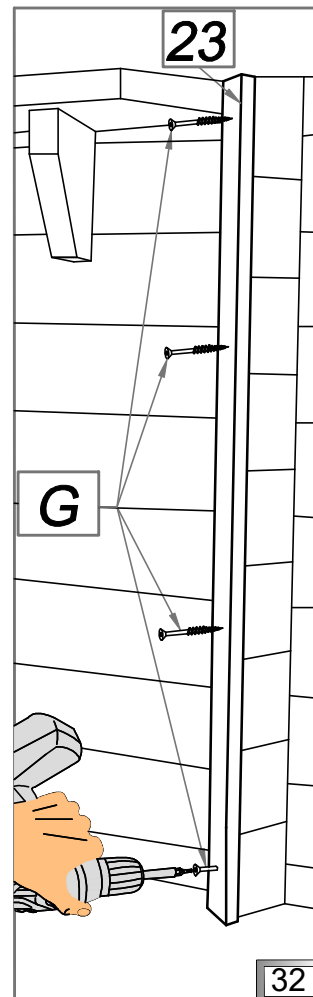
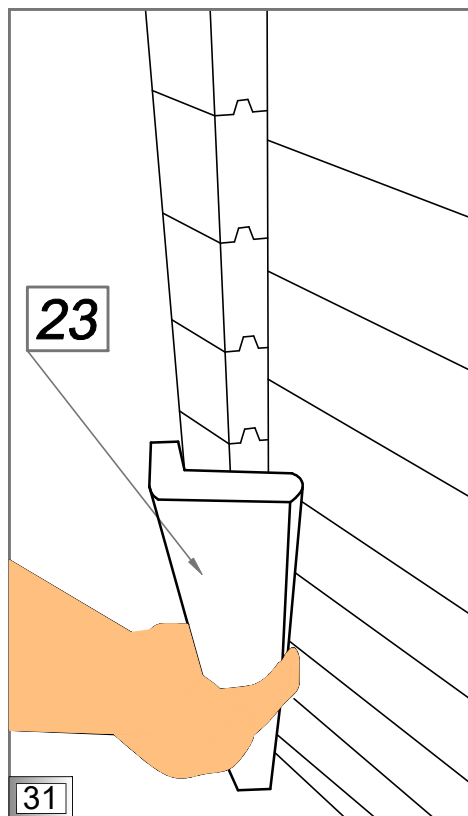
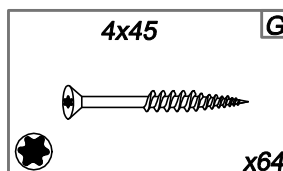
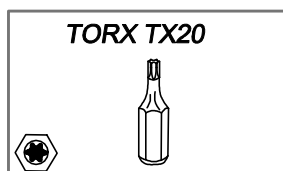
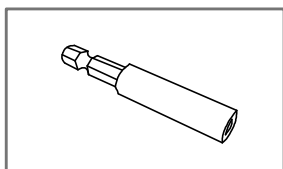
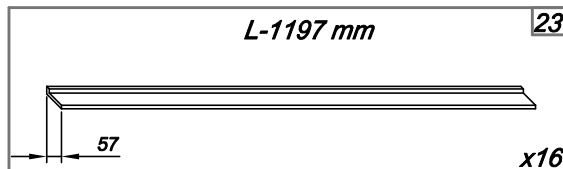
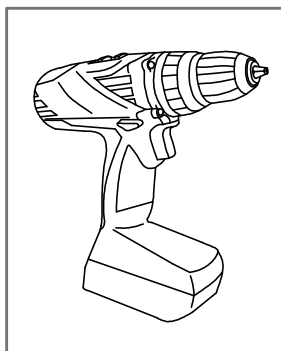

**(PL) Zawiasa tarasu skimmera**   **(GB) Skimmer terrace hinge**   **(DE) Skimmer Terrassenscharnier**  
**(FR) Charnière de terrasse skimmer**   **(NL) Skimmer terrasscharnier**



**(PL)** Montaż zawiasy tarasu skimmera - przykładowy sposób montażu.  
**(FR)** Montez la charnière de terrasse du skimmer.  
**(GB)** Mount the skimmer terrace hinge.  
**(IT)** Montare la cerniera della terrazza skimmer.  
**(DE)** Montieren Sie das Scharnier der Skimmerterrasse.  
**(NL)** Monteer het terrasscharnier van de skimmer.

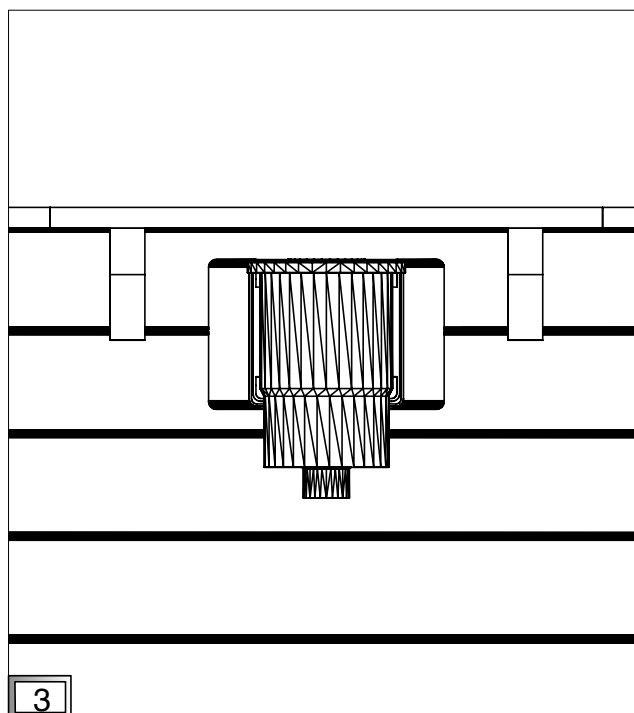
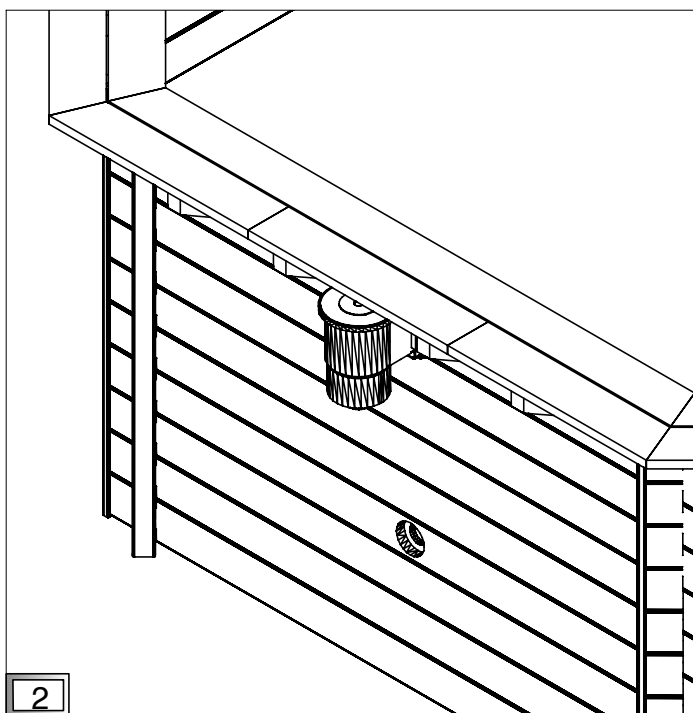
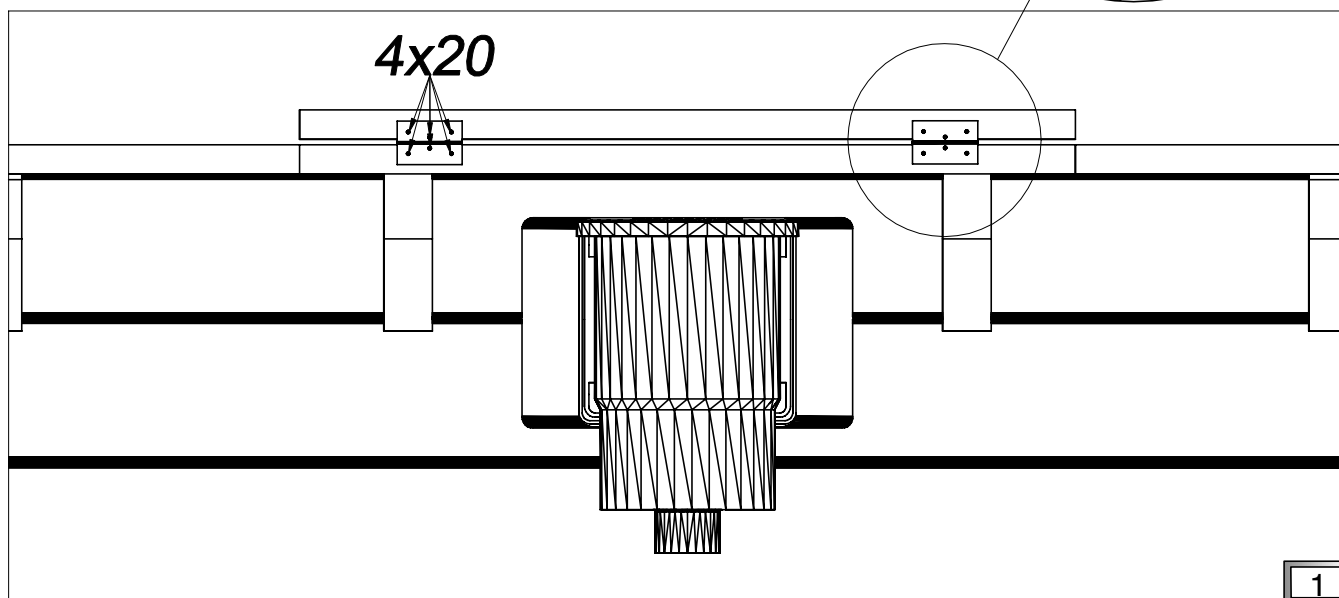
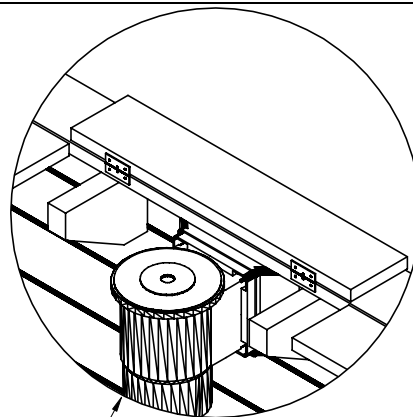
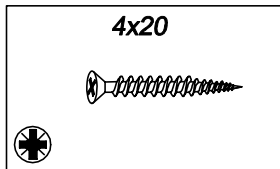
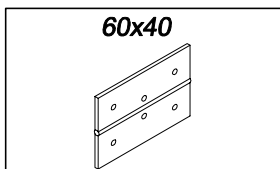

**PL** Struktura drewniana

**GB** Wooden structure

**D** Holzstruktur

**FR** La structure bois

**IT** Struttura in legno

**RU** Деревянная структура



**PL** Montaż łącznika karo (19) od spodu desek tarasowych.

**FR** Le montage des jonctions (19) en dessous des margelles.

**GB** Installation of wooden connector (19) to the bottom of terrace boards.

**IT** Montaggio di raccordo (19) dal fondo delle tavole da terrazza.

**D** Montage vom Caro- Bindeglied (19) von der Unterseite des Terrassenholzes.

**RU** Монтаж соединителя «ромб» (19) снизу досок террасы.

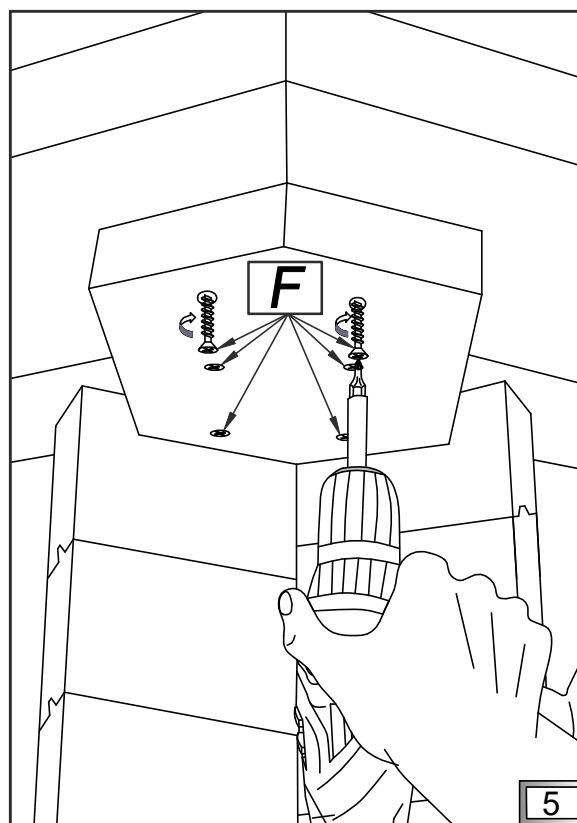
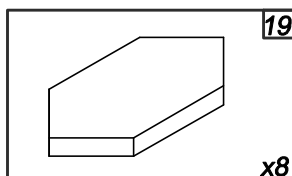
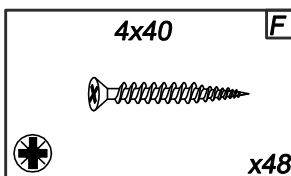
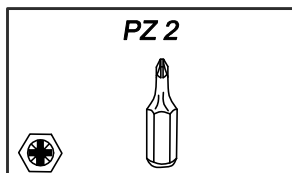
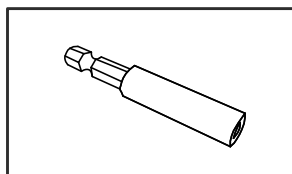
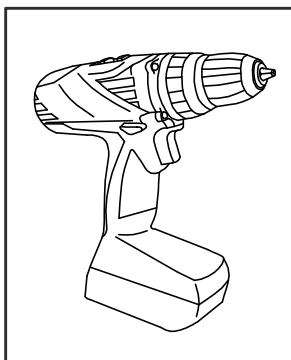

**PL** Widok od spodu tarasu.  
**FR** La vue du dessous des margelles.  
**GB** View from the bottom of terrace.  
**IT** Vista in fondo della terrazza.  
**D** Sicht vom unten der Terrasse.  
**RU** Вид снизу террасы.

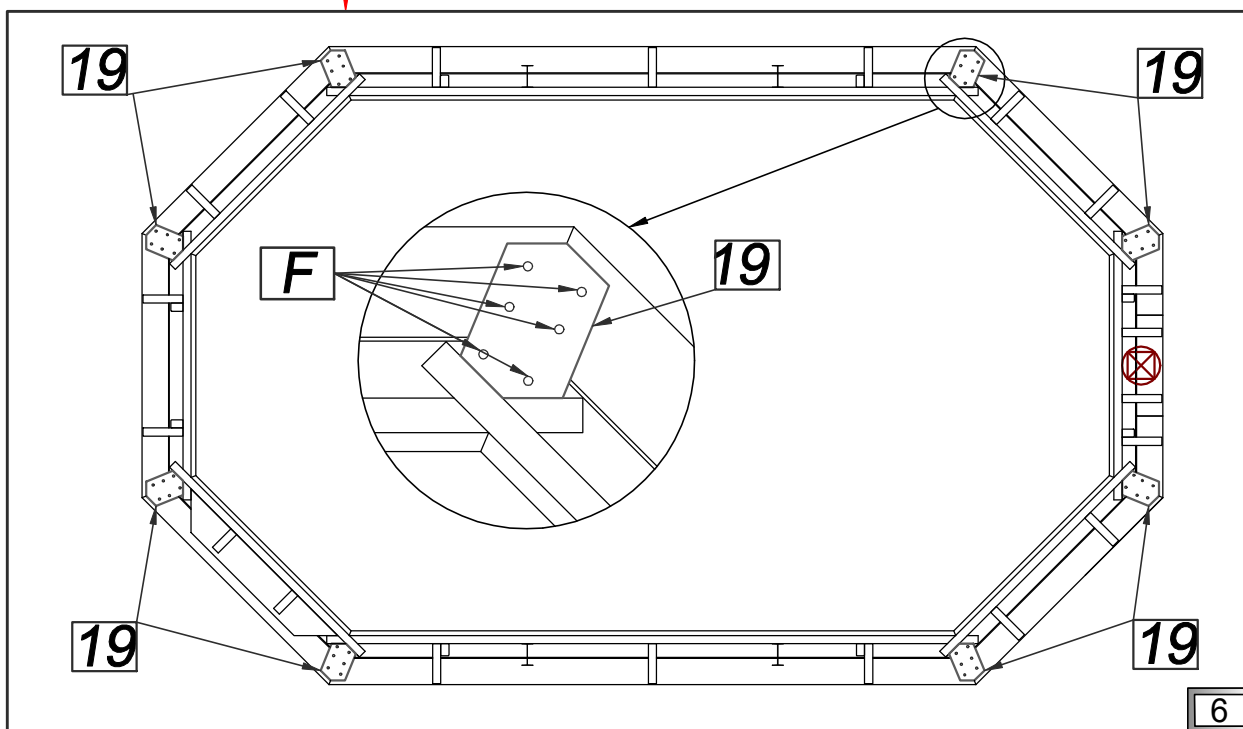

**PL** Schody drewniane

**GB** Wooden stairs

**D** Holztreppe

**FR** L'escalier bois

**IT** Scale di legno

**RU** Деревянная лестница



**PL** Montaż schodów.

**FR** Le montage de l'escalier.

**GB** Installation of stairs.

**IT** Montaggio delle scale.

**D** Montage von Treppen.

**RU** Монтаж лестницы.

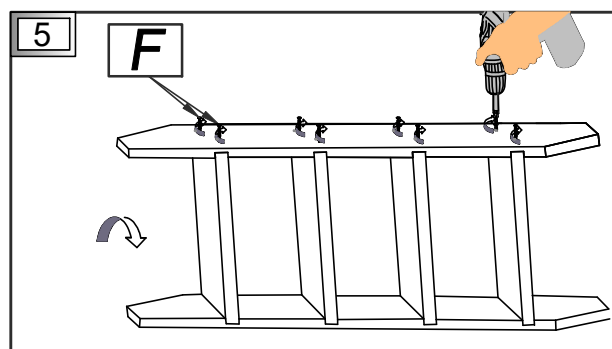
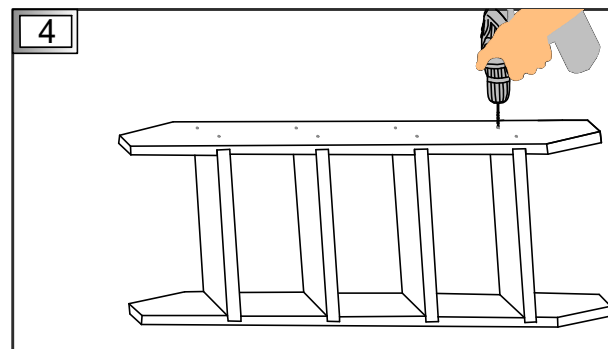
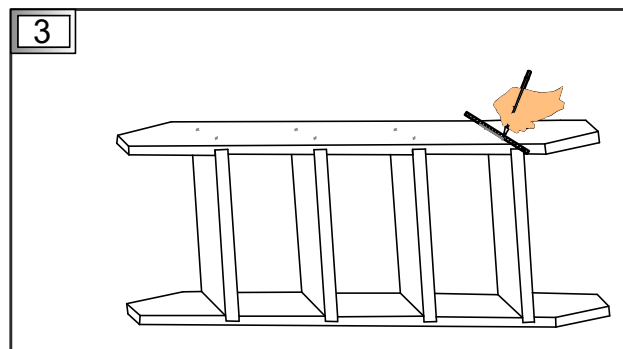
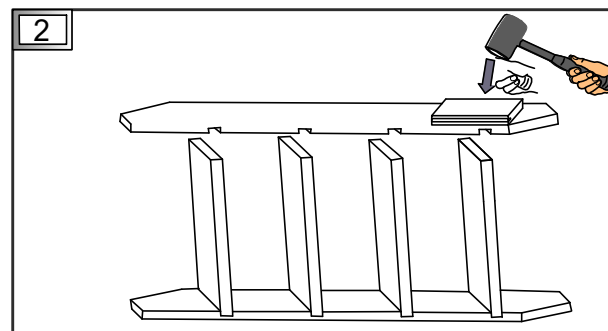
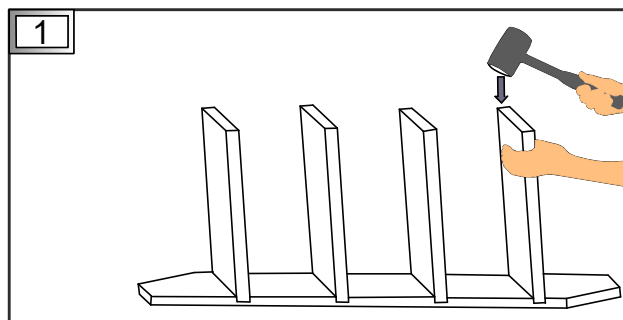
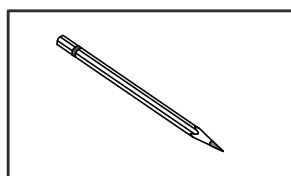
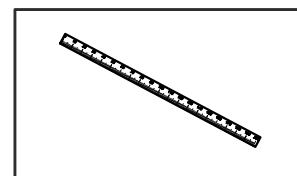
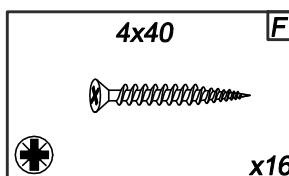
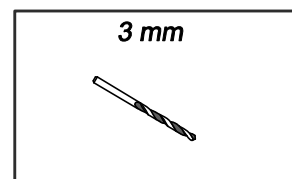
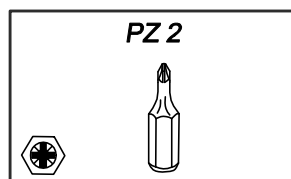
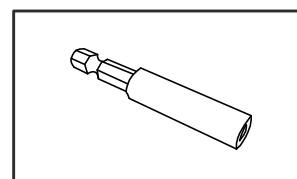
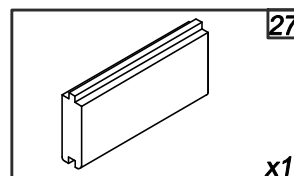
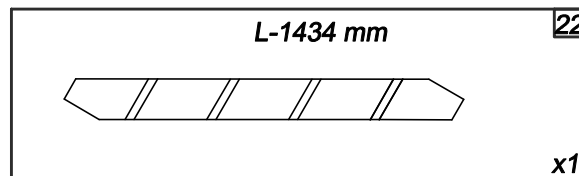
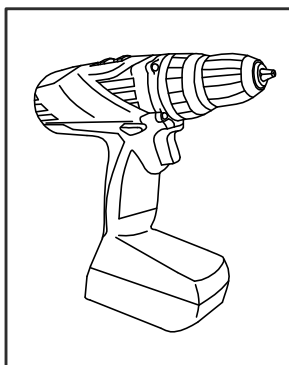
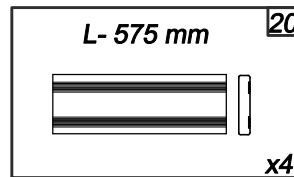
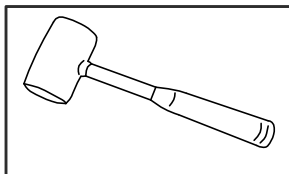

**PL** Schody drewniane

**GB** Wooden stairs

**D** Holztreppe

**FR** L'escalier bois

**IT** Scale di legno

**RU** Деревянная лестница



**PL** Montaż zawieszki (B1, B2). Schody mocujemy na ścianie ze wspornikiem schodów (7).

**FR** Le montage des boucles et des gâches (B1, B2). Fixez l'escalier sur la paroi avec le renfort d'escalier (7).

**GB** Installation of tag and hook kit (B1, B2). Stairs are mounted on the wall with stairs support (7).

**IT** Montaggio del manico (B1, B2). Le scale sono fissate al muro con uno sbalzo di scale (7).

**D** Montage vom Gehänge (B1, B2). Die Treppe ist an die Wand mit Treppenstützen (7) zu montieren.

**RU** Монтаж крючка (B1, B2). Лестница крепится на стене с кронштейном лестницы (7).

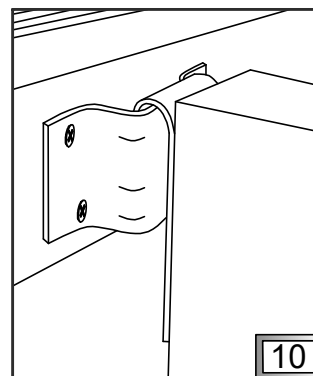
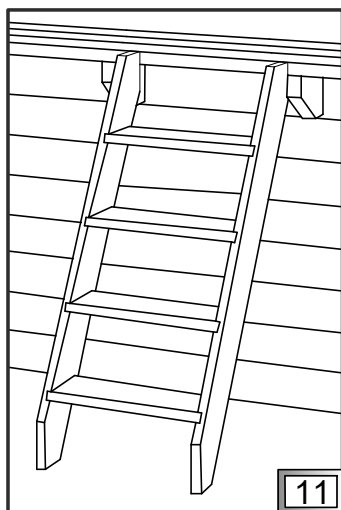
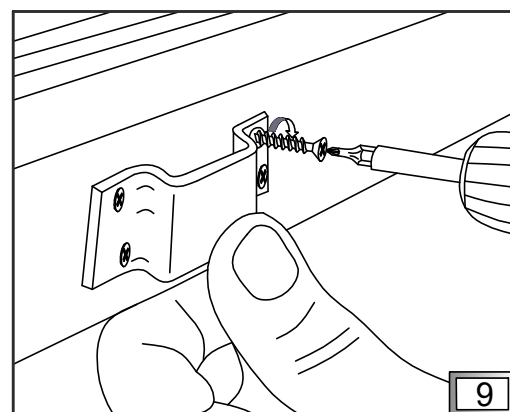
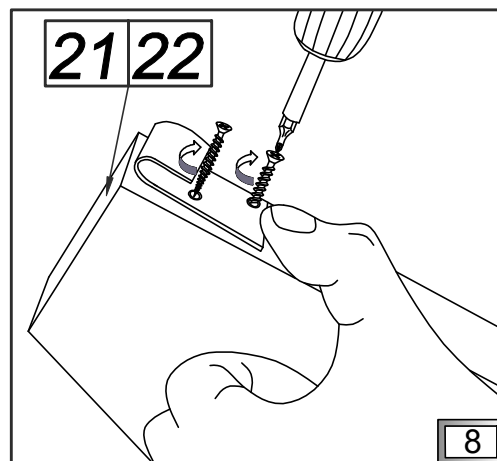
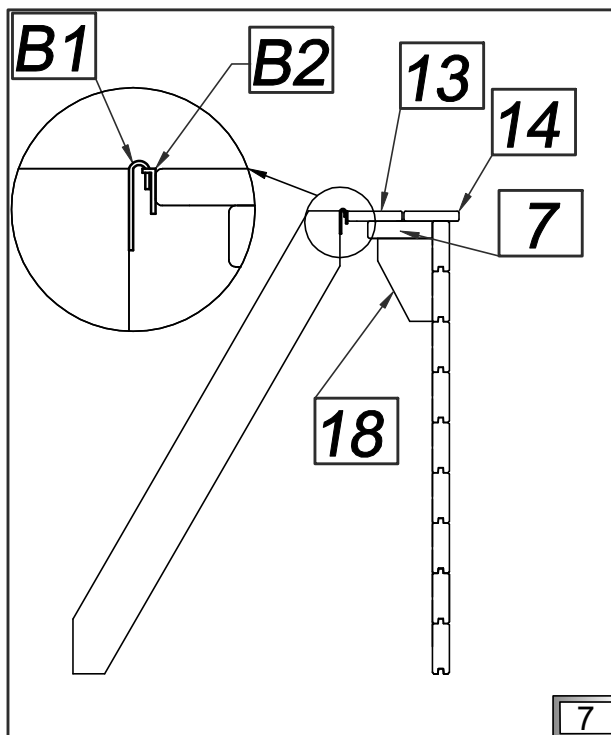
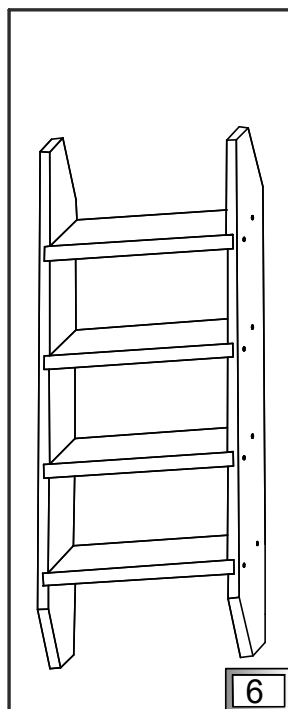
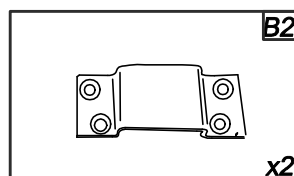
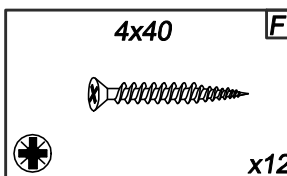
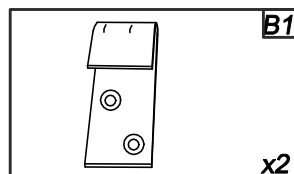
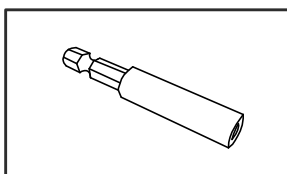
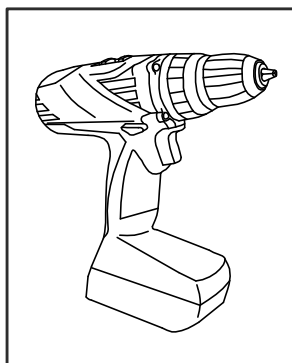

**PL** Maskownice

**GB** Corners covers

**D** Abdeckungen

**FR** Les caches

**IT** Mascherini

**RU** Маскировочный



- PL** Montaż maskownic (Y) do desek tarasowych.
- FR** Le montage des caches (Y) pour les margelles.
- GB** Mounting covers (Y) for corners of terrace boards.
- IT** Montaggio di mascherini (Y) per le tavole da terrazza.
- D** Montage der Abdeckungen (Y) ans Terrassenholz.
- RU** Монтаж маскировочных экранов (Y) к доскам террасы.

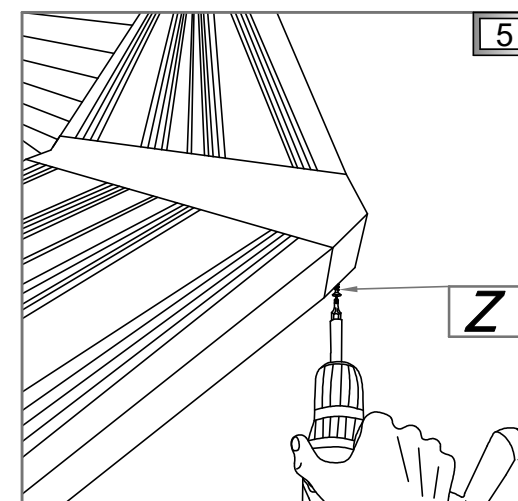
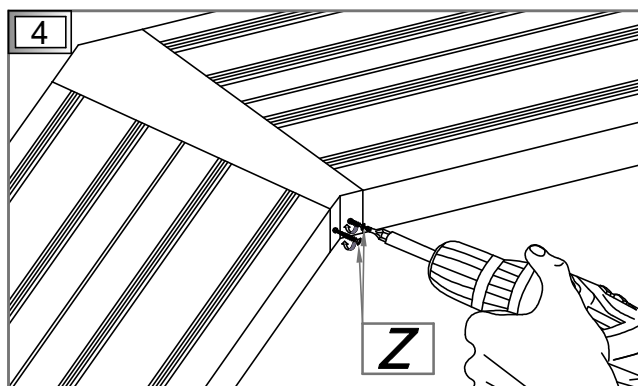
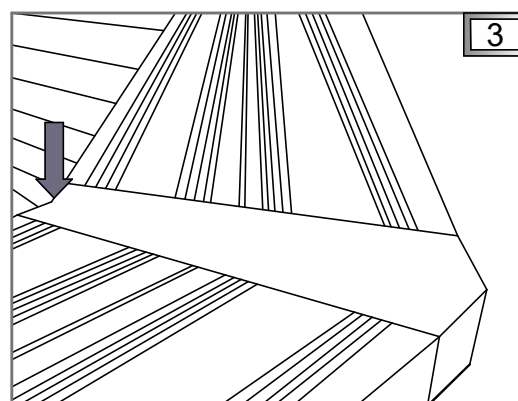
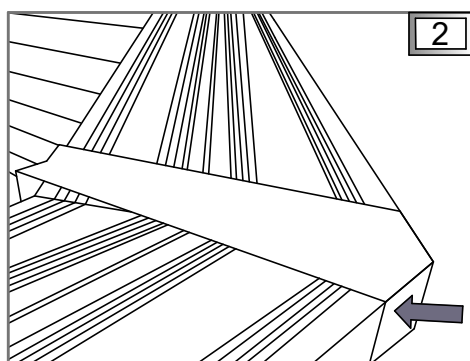
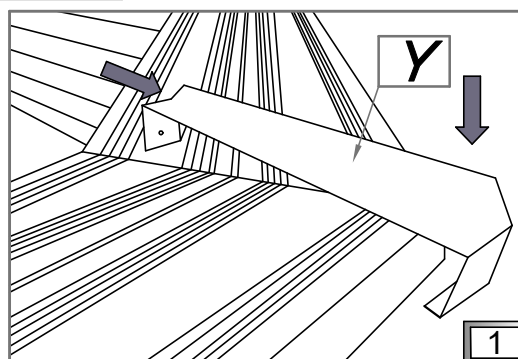
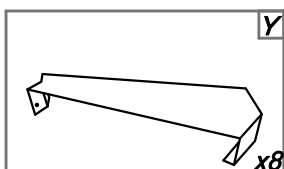
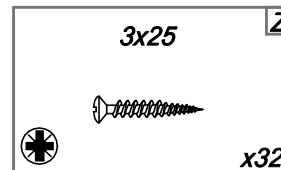
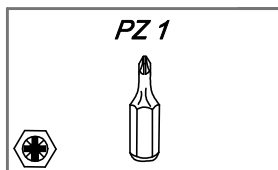
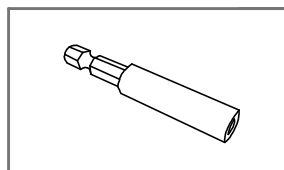
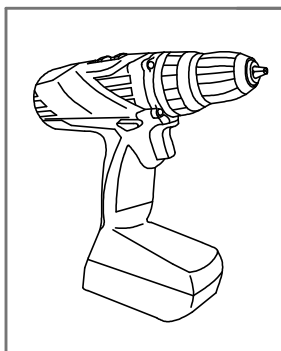

- PL** Widok od spodu tarasu.
- FR** La vue du dessous des margelles.
- GB** View from the bottom of terrace.
- IT** Vista in fondo della terrazza.
- D** Sicht vom unten der Terrasse.
- RU** Вид снизу террасы.

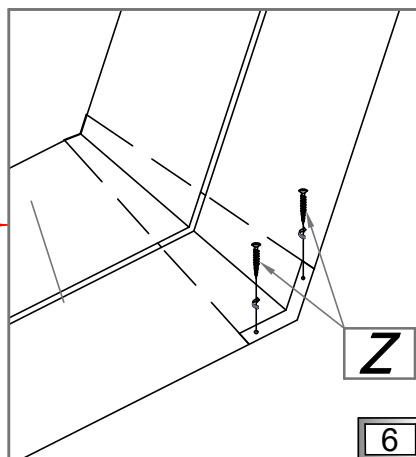

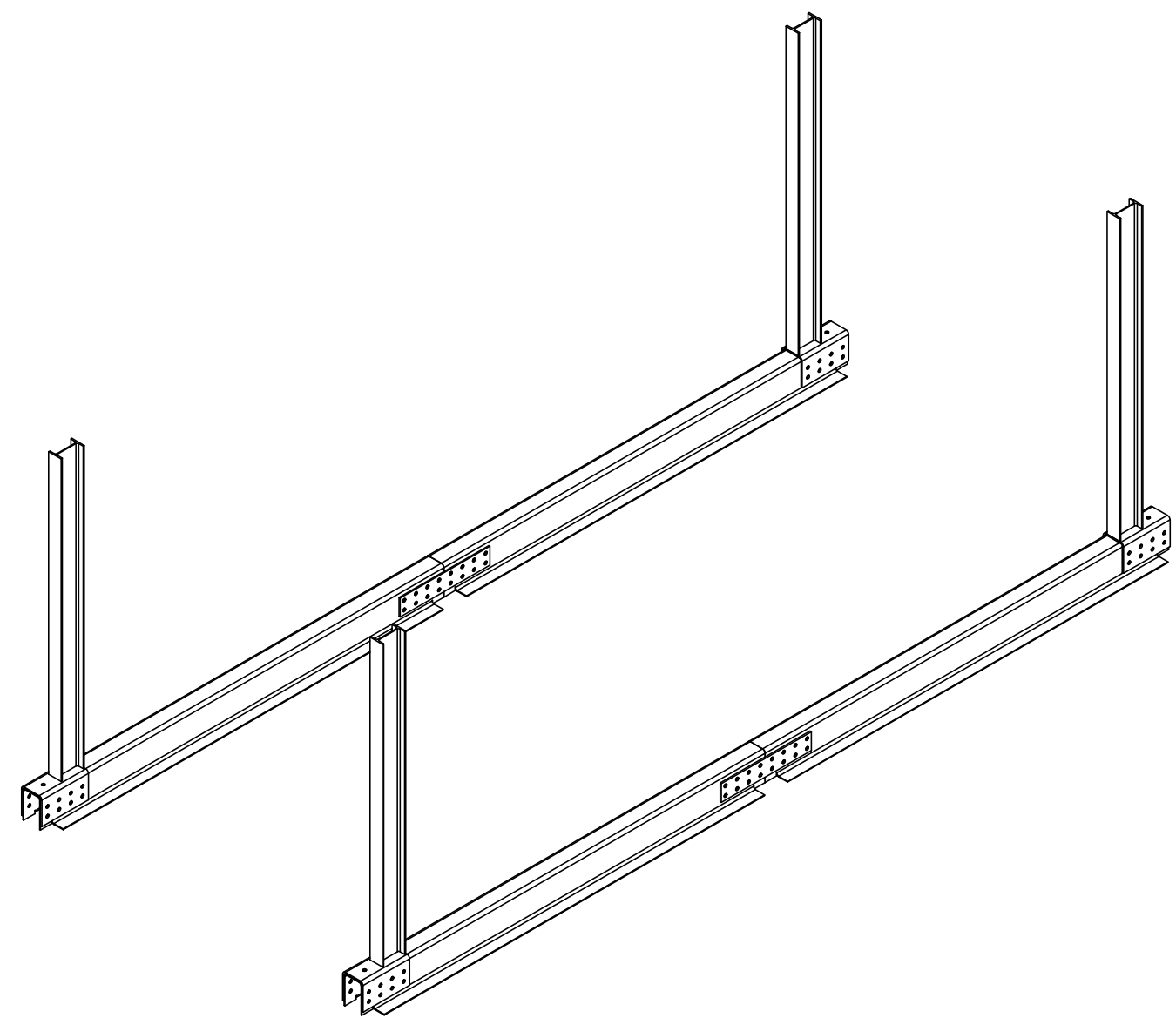
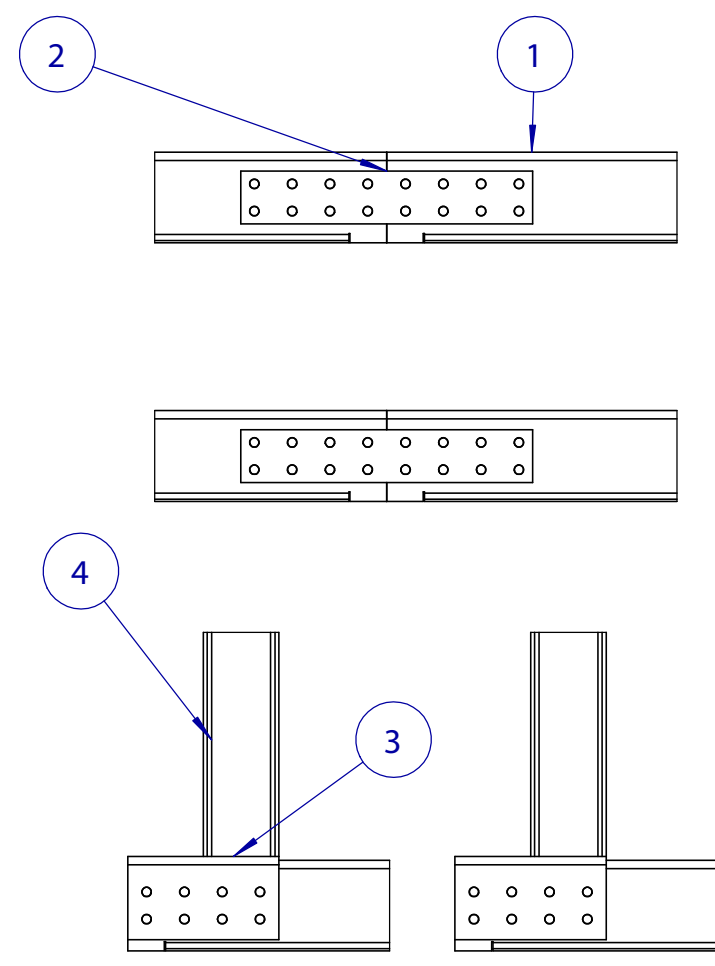
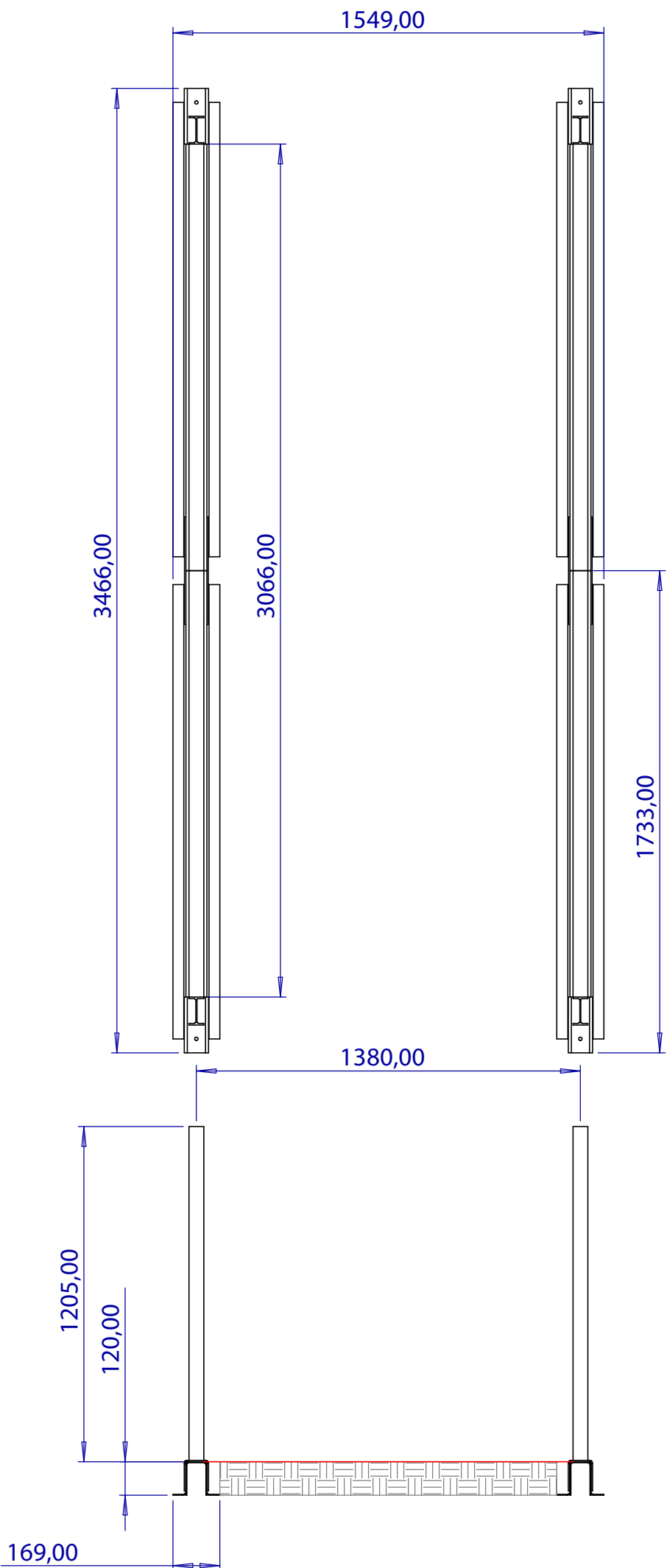

Num. articolo	Num. parte	COD ART	Quantità
1	INT_0050_03A_OMEGA_560	8030134	4
2	INT_0022_13_PIASTRA_LINEARE_v01	4030039	4
3	INT_0022_09_PROFILO_U_v04	4030030	4
4	INT_0050_02D_IPE_100_1200	8030101	4

**Codice Articolo 8031038**

INT\_0050 .cod. id. unico  
 .cod. id parte  
 INT\_0050\_ASS02 .cod. id assieme  
 C.P.A. SRL .committente  
**RIVA 560**  
 KIT AUTOPORTANTE 560

06/10/2021
Rev. 00
foglio 1 di 1
scala 1:20
dis. n° 02